

ABS

LÁMPARAS ESTÁNDAR



Modelo	W	Rosca	Luz	Lumen		Precio € Tarifa	
--------	---	-------	-----	-------	--	--------------------	--

Lámpara opal MS-A60 tipo estándar de Led
175-240V 50-60Hz. Apertura 160° MD-A60

BLISTER

41686	10W	E27	3000K	850	10	7,40	
41687		E27	6000K	850	10	7,40	

41661	6W	E27	3000K	480	12	4,40	
41662		E27	6000K	480	12	4,40	

41665	10W	E27	3000K	850	12	7,40	
41740		E27	4000K	850	12	7,40	
41912		E27	6000K	850	20	7,40	

41667	12W	E27	3000K	1050	12	8,90	
41741		E27	4000K	1050	12	8,90	
41668		E27	6000K	1050	12	8,90	

41916	16W	E27	3000K	1350	20	14,90	
41918		E27	6000K	1350	20	14,90	

41772	20W	E27	3000K	2180	12	19,50	
41773		E27	6000K	2180	12	19,50	

Lámpara opal tipo estándar con sensor, 50-60Hz. Apertura 160°

**CON
SENSOR
CREPUSCULAR**

41292	10W	E27	4000K	810	12	16,90	
-------	------------	-----	-------	-----	----	-------	--



4,5W

BLISTER



5W



7W



4,5W

BLISTER



5W

7W



Código	Rosca	Luz	Lumen		Precio € Tarifa	
Lámpara opal tipo esférica de Led - 220-240V 50-60Hz. 4,5W.						
41680	E27	3000K	330	10	6,70	
41682	E14	3000K	330	10	6,70	

Lámpara opal tipo esférica de Led - 220-240V 50-60Hz. 5W.						
41601	E27	3000K	360	10	6,70	
41602	E27	6000K	360	12	6,70	
41603	E14	3000K	360	12	6,70	
41604	E14	6000K	360	12	6,70	

Lámpara opal tipo esférica de Led - 220-240V 50-60Hz. 7W.						
41671	E27	3000K	550	12	7,90	
41744	E27	4000K	550	12	7,90	
41672	E27	6000K	550	12	7,90	
K62024	E14	3000K	550	12	7,90	
41674	E14	6000K	550	12	7,90	

- Medidas: 75mm. X 45mm.
- Ángulo de apertura: 140°.

Lámpara opal tipo vela de Led - 220-240V 50-60Hz. 4,5W.						
41684	E14	3000K	330	10	6,70	

Lámpara opal tipo vela de Led - 220-240V 50-60Hz. 5W.						
41605	E14	3000K	360	12	6,70	
41606	E14	6000K	360	12	6,70	

Lámpara opal tipo vela de Led - 220-240V 50-60Hz. 7W.						
K62030	E14	3000K	550	10	7,90	
41746	E14	4000K	550	12	7,90	
41676	E14	6000K	550	12	7,90	

CRISTAL



**Luz
360°**



Código	Rosca	Luz	Lumen		Tarifa	
--------	-------	-----	-------	---	--------	--

Lámpara opal tipo estandar de Led **360°** - 220-240V 50-60Hz. 10W.

41774	E27	3000K	1000	12	9,90	
41775	E27	6000K	1000	12	9,90	

Lámpara opal tipo esférica de Led **360°** - 220-240V 50-60Hz. 5W.

41940	E27	3000K	500	12	4,95	
41941	E27	6000K	500	12	4,95	
41942	E14	3000K	500	12	4,95	
41943	E14	6000K	500	12	4,95	

Lámpara opal tipo vela de Led **360°** - 220-240V 50-60Hz. 5W.

41944	E14	3000K	500	12	4,95	
41945	E14	6000K	500	12	4,95	



ABS

SERIE 12V Y 24V

Lámpara opal tipo estandar de Led **12V** - 220-240V 50-60Hz. **7W**.

41840	E27	4000K	560	12	7,90	
-------	-----	-------	-----	----	-------------	--

Lámpara opal tipo esférica de Led **12V** - 220-240V 50-60Hz. **5W**.

41845	E27	4000K	360	12	6,50	
-------	-----	-------	-----	----	-------------	--

Lámpara opal tipo esférica de Led **12/24V** - 220-240V 50-60Hz. **5W**.

41846	E27	4000K	360	12	8,60	
-------	-----	-------	-----	----	-------------	--

Lámpara dicroica MR16 **12V**, 50-60Hz. Apertura 120° **8W**

41847	MR16	3000K	640	12	10,80	
41848	MR16	6000K	640	12	10,80	



FUNCIONA COMO UNA LÁMPARA TRADICIONAL Y COMO UNA DE EMERGENCIA



Lámpara Led SMD emergencia cuerpo ABS, 220-240V 50-60Hz.

41293	7W	E27	3000K	400	12	21,90	
41294	7W	E27	6000K	400	12	21,90	



**SE CONTROLA
CON UNA APP
DESDE EL MÓVIL**

- Totalmente dimable.
- Todo tipo de tonos de luz (16 millones de colores).
- Programable/ auto-encendido.
- 8 modos pre-programados.
- Velocidad ajustable.
- Control por voz y movimiento.
- Posibilidad de sincronizar con varias unidades a la vez.
- Muy fácil de manejar.



Lámpara Led SMD "FIESTA", 220-240V 50-60Hz.

41600	8W	E27			6	54,80	
-------	----	-----	--	--	---	-------	--

LÁMPARAS LED FILAMENTO



Precio €

Código	Medidas	Rosca	Luz	Lumen	watios		Tarifa
--------	---------	-------	-----	-------	--------	--	--------

Lámpara tipo ST64 VINTAGE de Led

41787		115X55	E27	2700K	810	6W	6/12	19,60
-------	---	--------	-----	-------	-----	-----------	------	--------------

Lámpara tipo filamento A60 de Led

41533		106X60	E27	6400K	400	5W	12	6,40
41780		106X60	E27	2700K	600	6W	12	7,20
41781		106X60	E27	2700K	1020	8W	12	9,80

Lámpara tipo filamento A45 esférica de Led

41783		78,5X45	E27	2700K	320	4W	10	5,60
41537		78,5X45	E14	6400K	240	3W	10	5,30

Lámpara tipo filament Vela de Led

41785		100X35	E14	2700K	320	4W	12	5,60
-------	---	--------	-----	-------	-----	-----------	----	-------------

ABS



Modelo		Rosca	Luz	Lumen		Precio € Tarifa	
Lámpara SERIE R50 de Led, 220-240V 50-60Hz.							
41693	8W	E14	3000K	600	12	6,20	
41694		E14	6000K	600	12	6,20	
Lámpara SERIE R63 de Led, 220-240V 50-60Hz.							
41695	10W	E27	3000K	750	12	7,60	
41696		E27	6000K	750	12	7,60	
Lámpara SERIE R80 de Led, 220-240V 50-60Hz.							
41697	13W	E27	3000K	975	12	10,40	
41698		E27	6000K	975	12	10,40	



Lámpara SERIE AR111 MARCA HEPOLUZ

12V	41798	15W	G53	3000K	1380	12	21,90	
220V	41799		GU10	3000K	1380	12	21,90	

Lámpara SERIE AR111 MARCA I-LIGHT

12V	67535	12W	G53	3000K	1100	50	21,90	
	67536		G53	4200K	1100	50	21,90	
67537	G53		6400K	1100	50	21,90		
220V	67541		GU10	4200K	1100	50	21,90	
	67542		GU10	6400K	1100	50	21,90	



Código	Rosca	Lum.	Luz		Precio €
Lámpara 220-240V. led 6W tipo - 50mm.					

41541	GU10	480	3000K	10	8,90
-------	------	-----	-------	----	-------------

- 14 SMD 50X35.
- Apertura 120°.

Lámpara 220-240V. led **9W** tipo - 50mm.

41566	GU10	750	2700K	10	21,80
-------	------	-----	-------	----	--------------

- 16 SMD 50X50.
- Apertura 120°.

Lámpara 220-240V. led **5W** tipo - 50mm.

41688	GU10	450	3000K	10	7,90
-------	------	-----	-------	----	-------------

41689	GU10	450	6000K	10	7,90
-------	------	-----	-------	----	-------------

Lámpara 220-240V. led **5W** tipo - 50mm.

41543	GU10	450	3000K	12	7,90
-------	------	-----	-------	----	-------------

41544	GU10	450	6000K	12	7,90
-------	------	-----	-------	----	-------------

- 40 SMD 35X35.
- Apertura 120°.

Lámpara 220-240V. led **8W** tipo - 50mm.

41862	GU10	640	3000K	12	10,80
-------	------	-----	-------	----	--------------

41863	GU10	640	6000K	12	10,80
-------	------	-----	-------	----	--------------

- Diámetro: 50mm.
- Apertura: 120°

COB LED

Lámpara 220-240V. SMD led **10W** tipo - 50mm.

41864	GU10	765	3000K	12	12,50
-------	------	-----	-------	----	--------------

41865	GU10	765	6000K	12	12,50
-------	------	-----	-------	----	--------------

- Cuerpo de ceramica
- Diámetro: 50mm.
- Apertura: 120°

10W

Lámparas LED G4 y G9



3W

Lámpara G4 GEL SMD Led 3W 12V - 50Hz.

41897	G4	3000K	210	12	5,95	
41898	G4	6000K	210	12	5,95	

- Medidas: 37X12mm.



3W

Lámpara G4 GEL **COB** Led 3W 12V - 50Hz.

41899	G4	3000K	230	12	8,90	
41900	G4	6000K	230	12	8,90	

- Medidas: 30X9mm.



3,5W

Lámpara G9 GEL Led 3,5W 220-240V - 50Hz.

41869	G9	3000K	210	10	8,90	
-------	----	-------	-----	----	-------------	--

- Medidas: 50X14mm.



5W

Lámpara G9 Led 5W 220-240V - 50Hz.

41870	G9	3000K	350	10	8,90	
41871	G9	6000K	350	10	8,90	

- Medidas: 50X14mm.



3,8W

Lámpara G9 Led 3,8W 220-240V - 50Hz.

41568	G9	2700K	300	10	8,90	
41569	G9	6500K	300	10	8,90	

ABS ESPECIALIDADES



5W

Lámpara lineal led J78mm R7S Diam. 23mm, 220-240V 50-60Hz.

67519	5W	R7S	3000K	480	10/50	15,20	
67520		R7S	6400K	500	10/50	15,20	

- Apertura 360°



10W

Lámpara lineal led J118mm R7S Diam. 23mm, 220-240V 50-60Hz.

67521	10W	R7S	3000K	980	10/50	19,90	
77918		R7S	4200K	1000	10/50	19,90	
67522		R7S	6400K	1000	10/50	19,90	

- Apertura 360°

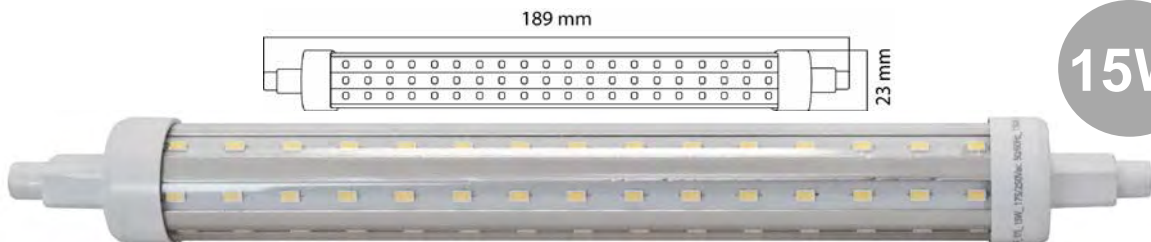

15W

Lámpara lineal led J189mm R7S Diam. 23mm, 220-240V 50-60Hz.

67524	15W	R7S	6400K	1500	10/50	25,10	
-------	------------	-----	-------	------	-------	--------------	--

- Apertura 360°

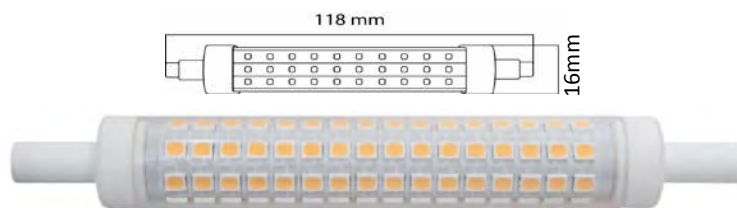

10W

Lámpara lineal **Super slim** led J118mm R7S Diam. 16mm, 220-240V 50-60Hz.

41766	10W	R7S	3000K	900	12/96	21,90	
41767		R7S	6000K	900	12/96	21,90	

- Apertura 360°.

- Presentación en Blister.



15W



2W



4W

Código	Rosca	Lum.	Luz		Precio €
Lámpara GLOBO					
41790	E27	1245	3000K	12	12,20
41791	E27	1245	6000K	12	12,20

- Medidas: Altura 156mm, Diámetro: 120mm



Lámpara Pebetero 2W

41796	E14	160	3000K	12	4,85
-------	-----	-----	-------	----	-------------

- Medidas: Altura 60mm, Diámetro: 26mm



Lámpara T25 filamento led 4W

41797	E14	400	3000K	12	5,80
-------	-----	-----	-------	----	-------------



- **Especial campana extractora**



- Medidas: Altura 84mm, Diámetro: 25mm





precio OFERTA solo para cajas completas

Código			Rosca	Luz	Lumen	watios		Precio€ Tarifa	
Lámpara LED PAR38 E27 Metal 220-240V 50-60Hz.									
41338		metalica	E27	6000K	960	12W	10	24,90	

Lámpara LED PAR38 E27 ABS 220-240V 50-60Hz.									
41339		ABS	E27	3000K	1600	18W	10	24,90	
41340		ABS	E27	VERDE	1600	18W	10	24,90	



ABS





Código	Medidas	Rosca	Luz	Lumen	watios	 Precio€ Tarifa
Lámpara alto vatage en LED						
41061	175X60	E27	6000K	1960	22W	10 16,20
41063	225X75	E27	6000K	2250	26W	10 20,60
41065	245X72	E27	6000K	2940	32W	10 27,20
41067	275X80	E27	6000K	3530	38W	10 31,60

- Tipo de LED SMD.
- Compatibilidad electromagnética WEEE Aprobado.
- EMC Aprobado.

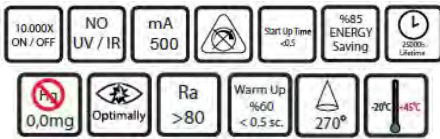
Lámparas SEMI industriales



Código	Medidas	Rosca	Luz	Lumen	watios		Precio € Tarifa	
Lámpara alto vatage en LED								
41071		151X81	E27	6000K	1690	20W	10	16,90
41073		185X100	E27	6000K	2540	30W	10	21,80
41075		214X118	E27	6000K	3250	40W	10	26,80



31029		151X81	E27	4.200K	1.700	20W	10	16,90
31031		185X100	E27	4.200K	2.700	30W	10	21,80
31033		218X114	E27	4.200K	3.400	40W	10	26,80

Tubos LED



Código	Rosca	Luz	W	Lumen		Precio € Tarifa
Tubos T8 de Led						
41755	G13	4000K	9W	800	20	13,60
41757	G13	4000K	18W	1700	20	17,60
41759	G13	6000K	23W	2150	20	23,90

Fijo

Medidas: 600X26 mm.
1200X26 mm.
1500X26 mm.



**EXCELENTE
ACABADO**

**SMD
LED**

Para sustituir tubos fluorescentes con balastro magnético

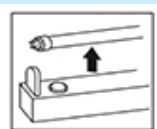

Paso 1º
Cortar la corriente principal y quitar el tubo fluorescente.

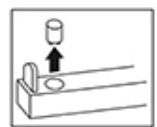

Paso 2º
Quitar el cebador. **Este tubo no necesita ningún cebador ni puenteado.**

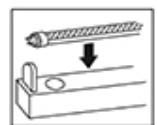

Paso 3º
Coloque el tubo de LED.

Importante:

En este caso la luminaria será conforme al estándar de la CE.

Para sustituir tubos fluorescentes con balastro electrónico

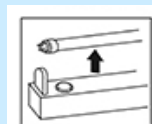

Paso 1º
Cortar la corriente principal y quitar el tubo fluorescente.

Paso 2º

Anular el balastro y conectar la FASE a un lado de la regleta y el NEUTRO al otro lado.



Tubos de cristal LED



TIRA LED COLOCADA EN GUIA NO PEGADA

Código	Rosca	Luz	W	Lumen		Precio € Tarifa	
Tubos T8 de Led							
41752	G13	6000K	9W	800	20	10,90	
41754	G13	6000K	18W	1650	20	12,90	
41750	G13	6000K	23W	2100	20	16,50	

Fijo

Medidas: 600X26 mm.
1200X26 mm.



Para sustituir tubos fluorescentes con balastro magnético

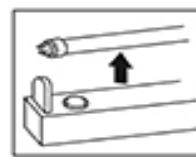

Paso 1º

Cortar la corriente principal y quitar el tubo fluorescente.

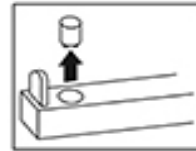

Paso 2º

Quitar el cebador. **Este tubo no necesita ningún cebador ni puenteado.**

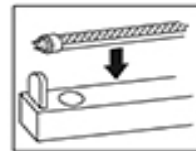

Paso 3º

Coloque el tubo de LED.

Importante:

En este caso la luminaria será conforme al

Para sustituir tubos fluorescentes con balastro electrónico

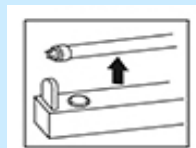

Paso 1º

Cortar la corriente principal y quitar el tubo fluorescente.

Paso 2º

Anular el balastro y conectar la FASE a un lado de la regleta y el NEUTRO al otro lado.





ABS



Modelo		Rosca	Luz	Lumen		Precio € Neto	
Lámpara opal MS-A60 tipo estándar de Led, 175-240V, 50-60Hz. Apertura 160°							
31001	5W	E27	3000K	500	10	3,90	
31002		E27	4200K	500	10	3,90	
31003		E27	6400K	500	10	3,90	
31004	6W	E27	3000K	600	10	4,40	
31005		E27	4200K	600	10	4,40	
31006		E27	6400K	600	10	4,40	
31007	8W	E27	3000K	850	10	5,30	
31008		E27	4200K	850	10	5,30	
31009		E27	6400K	850	10	5,30	
31010	10W	E27	3000K	1000	10	6,50	
31011		E27	4200K	1000	10	6,50	
31012		E27	6400K	1000	10	6,50	
31013	12W	E27	3000K	1050	10	7,90	
31014		E27	4200K	1050	10	7,90	
31015		E27	6400K	1050	10	7,90	
31022	10W	E27	3000K	900	10	7,50	
31023		E27	4200K	900	10	7,50	
21024		E27	6400K	900	10	7,50	
31019	8W	E27	3000K	600	10	9,20	
31020		E27	4200K	600	10	9,20	
31021		E27	6400K	600	10	9,20	





**ESPECIAL
DIMABLE**

**ESPECIAL
360°**

- Medidas de la lámpara 110X60 mm. - Tipo de LED SMD.
- Compatibilidad electromagnética WEEE Aprobado.- EMC Aprobado.

ABS



Código	Medidas	Rosca	Luz	Lumen	watios		Precio € Tarifa	
Lámpara opal tipo Vela de Led 110-240V 50-60Hz. Tipo de LED SMD								
31040		98X37	E14	3000K	250	3,5W	10	3,95
31042		98X37	E14	6400K	250		10	3,95
		131X37	E14	3000K	480	6W	10	
		131X37	E14	4200K	480		10	
31045		131X37	E14	6400K	480		10	4,90
Lámpara opal tipo Vela punta de Led								
31046		131X37	E14	3000K	250	3,5W	10	3,95
31048		131X37	E14	6400K	250		10	3,95
31049		131X37	E14	3000K	480	6W	10	4,90
31050		131X37	E14	4200K	480		10	4,90
		131X37	E14	6400K	480		10	
Lámpara opal tipo esférica de Led								
31052		73,3X45	E27	3000K	250	3,5W	10	3,95
31054		73,3X45	E27	6400K	250		10	3,95
31058		73,3X45	E27	3000K	480	6W	10	4,90
		73,3X45	E27	4200K	480		10	
		73,3X45	E27	6400K	480		10	
Lámpara opal tipo esférica de Led								
31055		73,3X45	E14	3000K	250	3,5W	10	3,95
31057		73,3X45	E14	6400K	250		10	3,95
31061		73,3X45	E14	3000K	480	6W	10	4,90
31062		73,3X45	E14	4200K	480		10	4,90
31063		73,3X45	E14	6400K	480		10	4,90

- Tipo de LED SMD.
- Compatibilidad electromagnética WEEE Aprobado.
- EMC Aprobado.

Lámparas LED de filamento



Código	Medidas	Rosca	Luz	Lumen	watios		Precio € Tarifa
--------	---------	-------	-----	-------	--------	---	--------------------

Lámpara opal tipo A60 de Led

31069		106X60	E27	3000K	320	4W	10	5,50
31070		106X60	E27	4200K	320		10	5,50
31071		106X60	E27	3000K	400	6W	10	6,80
31072		106X60	E27	4200K	400		10	6,80
31073		106X60	E27	3000K	500	8W	10	8,80
31074		106X60	E27	4200K	500		10	8,80

Lámpara opal tipo Vela de Led

31065		98X35	E14	3000K	320	4W	10	5,60
31066		98X35	E14	4200K	320		10	5,60

Lámpara opal tipo Vela punta de Led

31067		118X35	E14	3000K	320	4W	10	5,60
31068		118X35	E14	4200K	320		10	5,60

ABS



Precio €
Tarifa

Código	Modelo	Medidas	Rosca	Luz	Lumen	watios		Tarifa	
--------	--------	---------	-------	-----	-------	--------	---	--------	--

Lámpara GU10 Led
175-240V 50-60Hz.

Tipo de LED SMD

31100		55X50	GU10	3000K	250	4W	10	3,90	
31101		55X50	GU10	4200K	250		10	3,90	
31102		55X50	GU10	6400K	250		10	3,90	
31103		55X50	GU10	3000K	390	6W	10	5,40	
31104		55X50	GU10	4200K	390		10	5,40	
31105		55X50	GU10	6400K	390		10	5,40	
31106		55X50	GU10	3000K	630	8W	10	8,40	
31107		55X50	GU10	4200K	630		10	8,40	
		55X50	GU10	6400K	630		10		

Lámpara GU10 Led
175-240V 50-60Hz.

Tipo de LED SMD

	ESPECIAL DIMABLE	55X50	GU10	3000K	390	6W	10		
31111		55X50	GU10	4200K	390		10	7,90	
31112		55X50	GU10	6400K	390		10	7,90	

Lámpara Bi pin 12V DC Led

41893		34X12	G4	3000K	110	1,5W	25	2,90	
41894		34X12	G4	6400K	110		25	2,90	

Lámpara G9 Led

220-240V 50-60Hz.

41889		54X16	G9	3000K	180	3W	25	4,90	
41890		54X16	G9	6400K	180		25	4,90	
41891		54X16	G9	3000K	230	5W	25	5,90	
41892		54X16	G9	6400K	230		25	5,90	

- Tipo de LED SMD.
- Compatibilidad electromagnética WEEE Aprobado.
- EMC Aprobado.



Código	Casquillo	Luz	W	Lumen		Precio €
Lámpara Globo led 220-240V						
31161	E27	3000K	16	1400	50	12,50
31162	E27	4200K	16	1400	50	12,50
31163	E27	6400K	16	1400	50	12,50

- 220-240V / 50-60Hz.
- Vida útil: 25.000 horas.
- Medidas: 95X138mm.



**PRODUCTO
NUEVO**



Código	Casquillo	Luz	W	Lumen		Precio €
Lámpara Globo led 220-240V						
31164	E27	3000K	20	1650	20	16,40
31165	E27	4200K	20	1650	20	16,40
31166	E27	6400K	20	1650	20	16,40

- 175-240V / 50-60Hz.
- Vida útil: 25.000 horas.
- Medidas: 118X156mm.



**PRODUCTO
NUEVO**

SKYLIGHTING



Código	Rosca	Luz	Lumen	watios		Precio €
Lámpara PL Leds 175-250Vac - 50-60Hz.						
67108	G24	3000K	910	10	10	14,60
67590	G24	4200K	970	10	10	14,60
67591	G24	6400K	980	10	10	14,60

- Apertura 110°.
- Medida: 145mm.
- Diámetro: 38mm.



10W





Código	Rosca	Luz	Lumen		Precio €	
Lámpara MR16 Leds 12V						
67848	G5,3	3000K	560	10/50	8,60	
67849	G5,3	4200K	580	10/50	8,60	
67850	G5,3	6400K	600	10/50	8,60	

- Apertura 100° Medida: 55mm. diam. 50mm.



7W



Lámpara GU10 Leds 230V 50Hz.

77144	GU10	3000K	580	10/50	5,80	
77145	GU10	4200K	600	10/50	5,80	
77291	GU10	6400K	600	10/50	5,80	

- Apertura 100° Medida: 55mm. diam. 50mm.



7W



Lámpara tubular T25 LED 2W

77553	E14	3000K	218	10	6,30	
77545	E14	4200K	220	10	6,30	
77546	E14	6400K	220	10	6,30	

- Diámetro:25mm.
- Altura: 85mm.



2W



77776	E14	4200K	600	10	7,90	
77775	E27	4200K	600	10	7,90	

- Diámetro:30mm.
- Altura: 100mm.



6W



INDUSTRIALES

- Funcionamiento estándar entre -25°C y 50°C .
- Cuando la temperatura ronda los 70°C la lámpara se apaga por seguridad y cuando alcanza entre los 50°C y 60°C se enciende automáticamente.



Código	Rosca	Lum.	Luz		Precio €
Lámpara led 220-240V.					

67951	E27	2800	6400K	20	35,00
-------	-----	------	-------	----	-------

- Medida: 145x80mm.
- Apertura 160° .
- Numero de led: 90.

30W

Lámpara led 220-240V.

67832	E27	3800	6400K	10	108,00
-------	-----	------	-------	----	--------

- Medida: 160x78mm.
- Apertura 120° .
- Numero de led: 90.

40W

Lámpara 220-240V. Led, 50mm.

67835	E27	6600	6400K	5	149,00
-------	-----	------	-------	---	--------

- Medida: 170x78mm.
- Apertura 120° .
- Numero de led: 130.

70W

Lámpara 220-240V. Led, 50mm.

67838	E27	9500	6400K	5	192,00
-------	-----	------	-------	---	--------

- Medida: 198x88mm.
- Apertura 120° .
- Numero de led: 220.

100W

Lámpara 220-240V. Led, 50mm.

67841	E40	14200	6400K	5	345,00
-------	-----	-------	-------	---	--------

- Medida: 230x114mm.
- Apertura 120° .
- Numero de led: 290.

150W

ADVERTENCIA:

No colocar nunca en apliques o campanas cerradas, es importante que esté ventilado.



Tubos de cristal LED



Precio

Código	Medida	Luz	W	Lumen		tarifa
Tubos T8 de Leds						
67933	600mm	4200°K	10W	900	10	13,60
67934	600mm	6400°K	10W	940	10	13,60
67008	900mm	4200°K	15W	1100	10	15,90
67026	900mm	6400°K	15W	1200	10	15,90
67935	1200mm	4200°K	18W	1700	10	17,60
67936	1200mm	6400°K	18W	1780	10	17,60
67939	1500mm	4200°K	24W	2300	10	23,90
67940	1500mm	6400°K	24W	2400	10	23,90

- Eficiencia energética: A+
- Base: **G13**
- Diámetro: **26mm**
- Vida útil: **30.000**
- Dimable: **No**
- Índice cromático: **Ra80**
- Caja **10 pzs**

Para sustituir tubos fluorescentes con balastro magnético

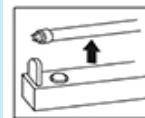

Paso 1º
Cortar la corriente principal y quitar el tubo fluorescente.

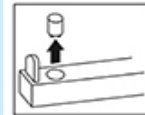

Paso 2º
Poner el cebador que trae el tubo.

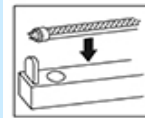

Paso 3º
Coloque el tubo de LED.

Importante:

En este caso la luminaria será conforme al estándar de la CE.

Para sustituir tubos fluorescentes con balastro electrónico ó directos

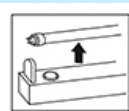

Paso 1º
Cortar la corriente principal y quitar el tubo fluorescente.

Paso 2º

Anular el balastro, desechar el cebador suministrado y conectar cada polo a las puntas que tienen la etiqueta. acabamos de conseguir tubos de conexión a una punta

Peligro:

Si conectamos en la punta contraria hacemos un cruce, ya que la punta que no tiene etiqueta, esta puenteada.

Giratorio 90º

Medidas:

- 600X26mm.
- 900X26mm.
- 1200X26mm.
- 1500X26mm.





Código	Medida	IP	Luz	W		Precio €
Disco de LED con transformador incorporado						
47965	180X30		3000	18W	10	18,40
47968	180X30		3000	22W	10	19,60

- 220-240V - 50Hz.
- Medidas: 180x30 mm.
- SMD LED 56x30, 48 pzas.
- Incluye 2 pinzas para downlight.
- Apertura 120°.
- Con 4 imanes.
- 30,000 horas.

Kit tira led 14,4W con controlador y transformador inclu.

4122235	RGB		RGB	14,4W	6	42,90
---------	-----	--	-----	-------	---	--------------

- La tira tiene tres metros
- 4,8 watos x metro.
- 60 SMD de 35X28m por metro.
- Los RGB de 35X28 son los 3 colores básicos.
- 288 lúmenes x metro.
- Base adhesiva.
- Presentación en blister

Tira led 5mts

HL540LF	5m	65	4200K	24W	1	12,90
HL540W	5m	65	6400K	24W	1	12,90
HL540LG	5m	65	VERDE	24W	1	12,90
HL540LR	5m	65	ROJO	24W	1	12,90
HL540LB	5m	65	AZUL	24W	1	12,90
HL540R	5m	65	RGB	24W	1	12,90

- 4,8 watos x metro.
- 60 SMD de 35X28m por metro.
- Los RGB de 35X28 son los 3 colores básicos.
- 288 lúmenes x metro.
- Base adhesiva.
- Medida 2X8mm.
- Presentación en bolsa individual.

Tira led 5mts

HL542A	5m	65	3000K	72W	1	19,50
HL542W	5m	65	6400K	72W	1	19,50
HL542R	5m	65	RGB+W	72W	1	23,60

- 14,4 watos x metro.
- 60 SMD de 50X50m por metro.
- Los RGB+W de 50X50 se pueden hacer múltiples colores
- 864 lúmenes x metro.
- Base adhesiva.
- Medida 3X10mm.
- Presentación en bolsa individual.



RGB los SMD de 35X28 sólo llevan un color por led; rojo, verde y azul intercalados

RGB los SMD de 50X50 llevan los colores en el mismo led mas blanco lo cual permite hacer múltiples colores



2,80 €
por metro



Código	Rollo	IP		W / M		Precio €
Rollo Tira led 50mts						X Metro
HL543B	30000	65	AZUL	10	50	5,90
HL543G	30000	65	VERDE	10	50	5,90
HL543R	30000	66	ROJO	10	50	5,90

- Voltage 220-240V / 50-60Hz.
- 2 líneas tira de 9mm x 3mm
- 10 wattios x metro.
- 600 Lm. X metro.
- 1 metro 60 Led tipo 50X50 SMD.
- Angulo 120°.
- Rollos de 50 mts. [Con 1 bolsa de accesorios por rollo](#)



**PUEDA
CORTARSE
CADA 1 MT.**

41992	Set		9mm.		10	9,40
-------	-----	--	------	--	----	------

Cada bolsa de accesorios contiene:

- Conexión a red: 1 ud.
- Pincho de conexión: 1 ud.
- Empalme de conexión: 1 ud.
- Tapón: 1 ud.
- Grapas: 5 uds.

Rollo Tira led 50mts

41987	30000	65	3000K	10	50	5,90
41986	30000	65	6400K	10	50	5,90

- Voltage 220-240V / 50-60Hz.
- 2 líneas tira de 7mm x 3mm
- 10 wattios x metro.
- 600 Lm. X metro.
- 1 metro 60 Led tipo 50X50 SMD.
- Angulo 120°.
- Rollos de 50 mts.

Con 1 conexión a tira



**PUEDA
CORTARSE
CADA 1 MT.**



Repuesto para tira HL543

HL54	Conexión a red			10	6,40
HL55	Empalme conexión			5	1,20
HL56	Tapón			10	0,30
HL57	Grapas			10	0,30

41991	Set		7mm.		10	9,40
-------	-----	--	------	--	----	------

Cada set contiene:

- Conexión a red: 1 ud.
- Pincho de conexión: 1 ud.
- Empalme de conexión: 1 ud.
- Tapón: 1 ud.
- Grapas: 5 uds.



1W



3W



Código	Lumen	Rollo	IP		W / M		Precio €
Rollo Tira led 100mts							
41985	3100	44	Blanca		1,8	100	4,60
41990	3100	44	Colores		1,8	100	4,60

- **Voltage 220-240V / 50-60 Hz.**
- 2 líneas - tubo de 13mm.
- 1,8 watos x metro.
- 30 lamp. por metro.
- 31 lúmenes x metro,
- 10 bolsas de accesorios,
- Presentación en rollo de 100 metros.



**PUEDE
CORTARSE
CADA 2 MTS.**

Set de accesorios incluidos en cada rollo

- 10 conexiones a red.
- 10 conexiones entre tiras.
- 10 tapones finales.

Código	Rosca		Medida	Lumen		Precio €
Lámpara standar 16 colores led, 4W, 5 programas y mando.						
010653	E27		69,5X45	105	12	10,60



Lámpara colores esféricas SMD LED, 20.000 hr. Vida
220-240V 50-60Hz.

31075	E27		69,5X45	105	10	1,60
31076	E27		69,5X45	34	10	1,60
31077	E27		69,5X45	68	10	1,60
31078	E27		69,5X45	12	10	1,60

- Tipo de LED SMD.
- Compatibilidad electromagnética WEEE Aprobado.
- EMC Aprobado.

Lámpara opal tipo standar de Led

31079	E27		110X60	315	10	4,20
31080	E27		110X60	102	10	4,20
31081	E27		110X60	205	10	4,20
31082	E27		110X60	38	10	4,20



- Transfor. electrónico para leds.
- Entr. 220-240AC - Sal. 12V DC.
- Medidas: 77X50X20.
- Medidas: 85X58X37.

Código	W	P.V.
HL544	10W-0,8A	6,90



- Transfor. electrónico para leds.
- Entr. 220-240AC - Sal. 12V DC.
- Medidas: 140X32X27.
- Medidas: 168X98X38.

Código	W	P.V.
HL545	36-3A	9,90
HL546	60-5A	13,10



- Transfor. electrónico para leds.
- Entr. 220-240AC - Sal. 12V DC.
- Medidas: 200X98X42
- Medidas: 200X110X50.

Código	W	P.V.
HL547	120-10A	21,90
HL548	150-12A	23,90



- Transfor. electrónico para leds.
- Entr. 220-240AC - Sal. 12V DC.
- Medidas: 200X110X50.

Código	W	P.V.
HL549	200-17A	30,40



- Transfor. electrónico para leds.
- Entr. 220-240AC - Sal. 12V DC.
- Medidas: 180x30x20.

Código	W	P.V.
HL553	25-2A	14,90



- Transfor. electrónico para leds.
- Entr. 220-240AC - Sal. 12V DC.
- Medidas: 180x70x40 mm.

Código	W	P.V.
HL555	60-5A	33,10



- Transfor. electrónico para leds.
- Entr. 220-240AC - Sal. 12V DC.
- Medidas: 252x70x40 mm.

Código	W	P.V.
HL557	120-10A	60,50



- Transfor. electrónico para leds.
- Entr. 220-240AC - Sal. 12V DC.IP68

Código	W	P.V.
77140	60W	36,90



- Conexiones a red para tiras de leds.
- 1 macho y 1 hembra de 15 cm.
- Se puede utilizar como empalme de dos tiras ó para conectar a red.

Código	W	P.V.
41965	10 sets	2,30



CONTROL REMOTO

- Controlador RGB+mando Max.144W.
- Entr. DC12-24V Sda. DC12-24V.

Código	W	P.V.
41946	4A	27,30



CONTROL REMOTO

- Controlador RGB+mando Max.72W.
- Entr. DC12-24V Sda. DC12-24V.

Código	W	P.V.
HL560	2A	7,80

- El controlador - 41946 es para tira de :
 - 35X28 SMD máx.. 30 mts.
 - 50X50 SMD máx.. 10 mts.
 -
- El controlador - HL560 es para tira de - 35X28 SMD máx.15 mts.
- 50X50 SMD máx. 5 mts.



E-14

Código	Rosca	Color	W		Precio	Precio Neto
Mini espiral T2 220-240V						
41111	E14	2700	10	10/50	4,60	
41121	E14	6400	10	10/50	4,60	

- Medidas 10W: 90x35mm.



E-14



E-27

Mini espiral T2 220-240V						
41113	E14	2700	12	10/50	4,90	
41124	E27	6400	12	10/50	4,90	

- Medidas 12W: 91x42mm.



15W

Código	Color	V	W		Precio	Precio Neto
Lámpara bajo consumo 220-230V GU10 15W						
41301	GU10	2700K	15	10/50	8,80	
41302	GU10	4100K	15	10/50	8,80	

- Tubos T2. Lumenes 750
- 8.000 horas de vida.
- Medidas: 97X32mm.





Lámparas **MINI**



8.000 Horas

Código	Rosca	Color	W	Tbos.		Precio	Precio Neto
Súper minis bajo consumo 220-240V							
41224	E14	2700	11	6U	10/50	5,80	
41225	E14	2700	15	6U	10/50	6,30	

41210	E14	2700	9	3U	10/50	5,30	
41201	E14	4100	9	3U	10/50	5,30	
41211	E14	6400	9	3U	10/50	5,30	
41214	E14	2700	15	3U	10/50	6,30	

- Medidas: 100X35mm.

41185	E27	2700K	24	4	10/50	4,90	
-------	-----	-------	----	---	-------	-------------	--

- Medidas: 130X47mm.

41280	E27	6400K	32	4	10/50	8,90	
-------	-----	-------	----	---	-------	-------------	--

- Medidas: 190X58mm.

41282	E27	6400K	65	4	10/50	18,90	
-------	-----	-------	----	---	-------	--------------	--

- Medidas: 245X70mm.



**Presentación
caja a color**



12W

24W



105W

85W

65W

45W

Modelo	Medidas	Rosca	Luz	Vatios	Tube	Lumen		Tarifa	
Lámparas bajo consumo 220-240V 50-60Hz.									
41010	107X37	E14	6400K	12W	T3	500	10	4,20	
41017	107X45	E27	6400K	12W	T3	540	10	4,50	
77847	150X58	E27	VERDE	24W	T3	600	10	6,80	
41040	240X83	E27	6400K	65W	T5	2500	10	15,90	
41041	270X100	E27	6400K	85W	T5	3500	10	24,70	
41043	285X100	E27	6400K	105W	T6	4400	10	28,90	

- Vida media: 6.000 horas.



Código	Rosca	V	W		Precio €
--------	-------	---	---	---	----------

Lámpara PL bajo consumo 2PIN

41449	G24d1	4000K	13	25/100	3,40
-------	-------	-------	----	--------	-------------

- Medidas: 135X27mm.

Lámpara PL bajo consumo 2PIN

41453	G24d3	2700K	26	25/100	3,40
-------	-------	-------	----	--------	-------------

41454	G24d3	4000K	26	10/100	3,40
-------	-------	-------	----	--------	-------------

41455	G24d3	6400K	26	10/100	3,40
-------	-------	-------	----	--------	-------------

- Medidas: 170X27mm.



Lámpara L 4 PIN

77273	2G11	4000K	18W	10	4,75
-------	------	-------	-----	----	-------------

- Medidas: 225X38mm.

77279	2G11	4000K	36W	10	7,20
-------	------	-------	-----	----	-------------

- Medidas: 415X38mm.

77282	2G11	4000K	55W	10	8,60
-------	------	-------	-----	----	-------------

- Medidas: 535X38mm.

Lámpara S 2 PIN

41468	G23	4000K	9	10	3,40
-------	-----	-------	---	----	-------------

41469	G23	4000K	11	10	3,70
-------	-----	-------	----	----	-------------





Código	Tubo	Med.	W	Luz		Precio €
Mini tubo						
41621	T-5	212	6	6500	25	1,60
41622	T-5	288	8	6500	25	1,80
41623	T-5	517	13	6500	25	2,40

Tubo T8 Halofósforo, 6.500°K - Medidas especiales						
41655	T-8	450	15	6500	25	2,20

Tubo T8 Halofósforo 6500K						
41650	T-8	600	18	6500	25	1,90
41651	T-8	1200	36	6500	25	2,20

Tubo T8 Plus trifósforo, 6.500°K, Vida media 20.000 horas						
41624	T-8	600	18	4000	25	2,60
41626	T-8	1200	36	4000	25	3,20
41627	T-8	1200	36	6500	25	3,20
41628	T-8	1500	58	4000	25	4,20
41629	T-8	1500	58	6500	25	4,20

FABRICADO EN LA UNIÓN EUROPEA

Tubo circular trifósforo T-9 luz día						
41635	T-9	216	22W	6500	12	5,20
41636	T-9	305	32W	6500	12	6,60

Luz negra (BL350) Gama de Tubos especiales exterminador de insectos, señuelos, etc						
41640	T-5	212	6		10	3,80
41641	T-5	288	8		10	4,20
41642	T-8	438	15		10	5,60
41643	T-8	590	20		10	6,50



Anti-insectos

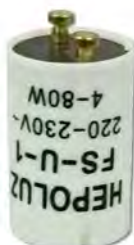
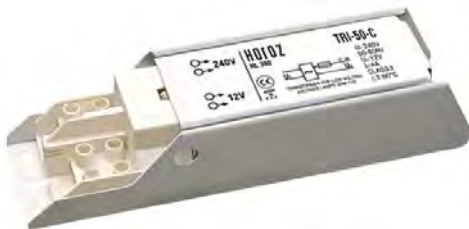

Código	Tubo	W		Precio €
Balastro electrónico 230V 50/60 Hz.				
HL382	230V 50/60hZ	18	12	5,40
HL384	230V 50/60hZ	36	12	6,40
HL385	230V 50/60hZ	2x18	12	8,40
HL386	230V 50/60hZ	2x36	12	11,40

- 200x20mm 18/36
- 240x30mm 2x18/2x36

Equipo Reactancia tipo 230V 50/60 Hz.

47939	230V 50/60hZ	2X13	6	3,80
47940	230V 50/60hZ	2X26	6	3,80

- Para Downlight. de 2X13Wy 2X26W

Transformador 240V a 12V 50/60 Hz.

HL360	230V-12V 50/60hZ	50	10	6,90
-------	------------------	----	----	-------------

- Para lámparas halógena.

Transformador electrónico 240V a 12V 50/60 Hz.

HL370	230V-12V 50/60hZ	60	10	6,90
-------	------------------	----	----	-------------

- Para lámparas halógena.

Cebadores Sylvania 220-240V

0024432	FS 11 - 4-65W		25/250	0,80
0024433	FS 22 - 4-22W		25/250	0,86

Cebadores Hepoluz 220-240V

41530	FS-U-1 4-22		48	0,55
41525	FS-U-2 4-80		20	0,55

Cebadores en blíster

41521	FS-U-1 4-22		20	0,95
41523	FS-U-2 4-80		20	0,95

APLIQUES DE TECHO Y PARED



**INTERIOR
EXTERIOR
TECHO/PARED**

**VARIEDAD
PRÁCTICOS
DECORATIVOS
MODERNOS**



Rejilla
metálica



Pantalla
de cristal



Código	Modelo		Precio €
Aplicque estándar con soporte			
4256111	Negro	4	5,60
4256112	Blanco	4	5,60

- Medidas: 175X125mm.
- IP43.
- Clase II máx.60W.
- 250V 1xE27.

VDE



Aplicque gris metálico con rejilla

4256200	Gris- 60W	4	6,30
4256300	Gris- 100W	2	10,80

- Medidas: 170X125mm.
- IP43.
- Clase II máx.
- 250V 1xE27.

VDE



Aplicque con rejilla

4266001	Negro	6	10,80
4266002	Blanco	6	10,80

- Medidas: Ø 220mm.
- IP44.
- Clase II máx. 75 máx.
- 250V 1xE27.
- Pantalla de cristal.

VDE



SERIE ALUMINIO



Código	Modelo		tarifa	
Apliques plano E27 máx. 60W				
HL901B	Blanco	12	8,80	
HL901N	Negro	12	8,80	
Medidas: 210x105x85.				
Apliques plano E27 max. 100W				
HL921B	Blanco	12	16,70	
HL921N	Negro	12	16,70	
Medidas: 275x155x120.				
Apliques plano redondo. E27 máx. 60W				
HL906B	Blanco	12	9,20	
HL906N	Negro	12	9,20	
Medidas: 170x80.				
Apliques plano redondo. E27 máx. 100W				
HL926B	Blanco	12	17,30	
HL926N	Negro	12	17,30	
Medidas: 240x115.				
Apliques plano E27 máx. 60W				
HL911B	Blanco	12	23,40	
HL911N	Negro	12	23,40	
Medidas: 265x130x105.				
Apliques plano E27 max. 60W				
HL902B	Blanco	12	9,60	
HL902N	Negro	12	9,60	
Medidas: 210X105X85.				
Apliques redondo E27 máx. 60W				
HL907B	Blanco	12	9,90	
HL907N	Negro	12	9,90	
Medidas: 170x80.				



Código	Color		Tarifa
Aplicador Md-Lolly rectangular interior-exterior			
42240	Blanca	5 / 60	3,80

- 220-240V , 1XE27.
- Bajo consumo max. 15W.
- Medidas: 225X74X70.



Aplicador MD. APLIK IP65

42242	Blanco	10	7,40
-------	--------	----	-------------

- 230V - 50Hz. Max. 40W.
- Anti golpes.
- Lámpara no incluida.
- Medidas: 200X85.



Aplicador MD. AQUA EKO

42243	Negro	10	7,40
-------	-------	----	-------------

- 230V - 50Hz. Max. 40W.
- Anti golpes
- Lámpara no incluida.
- Medidas: 200X85.

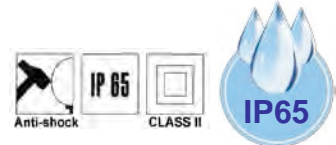

Aplicador MD. APLIK IP54

42238	Blanco	10	7,40
-------	--------	----	-------------

- 220-240V - 50Hz. E27 Max. 1X26W.
- Pantalla de policarbonato.
- Lámpara no incluida.
- Medidas: 246X140mm.



Aplicador MD. APLIK IP54

42239	Negro	10	7,40
-------	-------	----	-------------

- 220-240V - 50Hz. E27 Max. 1X26W.
- Pantalla de policarbonato.
- Lámpara no incluida.
- Medidas: 246X140mm.



Código	Color		Tarifa
Aplique MD. GLOP			
42202	Blanco	4 / 32	5,80

- 230V - 50Hz. Max. 40W .
- Lámpara no incluida.
- Medidas: 230X91mm.
- Presentación granel.
- 4 unidades por caja.



Aplique MD. UFO			
42203	blanco/rayas	5 / 40	4,80
42204	blanco/liso	5 / 40	4,80

- 230V - 50Hz. Máx. 40W.
- Lámpara no incluida.
- Medidas: 230X82,5mm.
- Presentación granel.
- 5 unidades por caja.



Aplique MD. OVAL			
42210	blanco/liso	4 / 36	5,20
42211	blanco/deco	4 / 36	5,20

- 230V - 50Hz. Máx. 26W B.Con.
- Lámpara no incluida.
- Medidas: 270x165x81.
- Presentación granel.
- 4 unidades por caja.





**EXTRA
BIG**

Código	Color		Tarifa	
Aplique MD. KARE MODERN				
42213	Blanco	1 / 12	10,60	

- Lámpara no incluida.
- Medidas: Diámetro 255X81mm.
- Presentación caja color 1.
- Máx. 1x26W (ESL).



Aplique MD. KARE MODERN BIG

42214	Blanco	1 / 10	17,60	
-------	--------	--------	-------	--

- Lámpara no incluida.
- Medidas: Diámetro 323X89mm.
- Presentación caja color 1.
- Máx. 2x26W (ESL).



Aplique MD. BULUT

42216	Blanco	1 / 5	18,40	
-------	--------	-------	-------	--

- Lámpara no incluida.
- Medidas: Diámetro 377X117mm.
- Presentación caja color 1.
- Máx. 2x26W (ESL).



Código	Color		tarifa	
--------	-------	---	--------	--

Aplique MD. AQUA RED, E27

42220	Blanco	10	18,80	
42221	Negro	10	18,80	
42222	Gris	10	18,80	

- 230V - 50Hz. Max. 60W.
- Lámpara no incluida.
- Medidas: Diám 275x99mm.



Anti-shock



CLASS II



IP65

Aplique MD. AQUA OVAL, E27

42230	Blanco	10	18,80	
42231	Negro	10	18,80	
42232	Gris	10	18,80	

- 230V - 50Hz. Max. 60W.
- Lámpara no incluida.
- Medidas: 325X235x98.



Anti-shock



CLASS II



IP65



Código	Color		Tarifa	
Aplique de pared OPAL MD-LUNA, E27				
42250	Blanco	20	8,40	
42251	Negro	20	8,40	

- 230V - 50Hz. Max. 40W.
- Medidas: 250X202X105.
- **Lámpara no incluida.**



Aplique de pared OPAL MD-LUNA, E27
C/sensor de movimiento

42403	Blanco	20	29,90	
42404	Negro	20	29,90	

- 230V - 50Hz. Max. 40W.
- Medidas: 250X202X105.
- **Lámpara no incluida.**



Aplique OPAL MD-LUNA LED 9W, 3.000°K.

42405	Blanco	20	22,90	
42406	Negro	20	22,90	

Aplique MD-OPAL LED 9W, 6.400°K.

42407	Blanco	20	22,90	
42408	Negro	20	22,90	

- 230V - 50Hz.
- Medidas: 250X202X105.



Aplique OPAL MD-LUNA LED 9W, 3.000°K.

C/sensor de movimiento				
42409	Blanco	20	36,90	
42410	Negro	20	36,90	

Aplique OPAL MD-LUNA LED 9W, 6.400°K.

C/sensor de movimiento				
42411	Blanco	20	36,90	
42412	Negro	20	36,90	

- 230V - 50Hz.
- Medidas: 250X202X105.





Código	Color		tarifa	
Aplique Opal-Redondo MOD. LUNA, E27				
42254	Blanco	16	8,40	
42255	Negro	16	8,40	

- 230V - 50Hz. Max. 40W.
- Medidas: 242,5X106.
- **Lámpara no incluida.**

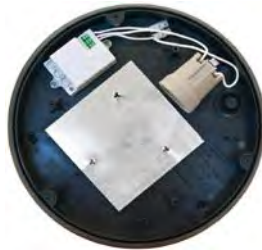

Aplique Opal-Redondo MOD. LUNA, E27
C/sensor de movimiento

42427	Blanco	16	29,90	
42428	Negro	16	29,90	

- 230V - 50Hz. Max. 40W.
- Medidas: 242,5X106.
- **Lámpara no incluida.**



Aplique Opal-Redondo MOD. LUNA LED,
12W, 3.000°K.

42429	Blanco	16	22,90	
42430	Negro	16	22,90	

Aplique Opal-Redondo MOD. LUNA LED,
12W, 6.400°K.

42431	Blanco	16	22,90	
42432	Negro	16	22,90	

- 230V - 50Hz.
- Medidas: 242,5X106.



Aplique Opal-Redondo MOD. LUNA LED,
12W, 3.000°K, C/sensor de movimiento

42433	Blanco	16	36,90	
42434	Negro	16	36,90	

Aplique Opal-Redondo MOD. LUNA LED,
12W, 6.400°K, C/sensor de movimiento

42435	Blanco	16	36,90	
42436	Negro	16	36,90	

- 230V - 50Hz.
- Medidas: 242,5X106.





CON SENSOR







CON SENSOR



CON SENSOR



CON SENSOR

Código	Modelo		Precio tarifa
Aplique con sensor			
42617	Gota	10	26,90
<ul style="list-style-type: none"> - Base metal - cubierta cristal. - 220-240V , 2X27. - IP20 - Bajo consumo max. 2x25W. - Sensor de movimiento 360° - Sensor de luz 2 a 240 lux. - Temperatura de trabajo -20°C a +50°C. - Tiempo: 15 a 270 seg. - Medidas: 300mm. 			
Aplique con sensor			
42246	Rombo	10	26,90
<ul style="list-style-type: none"> - Base metal - cubierta cristal. - 220-240V , 2X27. - IP20. - Bajo consumo max. 2x25W. - Sensor de movimiento 360° - Sensor de luz 2 a 240 lux. - Temperatura de trabajo -20°C a +50°C. - Tiempo 15 a 270 seg. - Medidas: 300mm. 			
Aplique con sensor			
42618	Cuadro	10	26,90
<ul style="list-style-type: none"> - Base metal - cubierta cristal. - 220-240V , 2X27. - IP20. - Bajo consumo max. 2x25W. - Sensor de movimiento 360° - Sensor de luz 2 a 240 lux. - Temperatura de trabajo -20°C a +50°C. - Tiempo 15 a 270 seg. - Medidas: 300mm. 			
Aplique con sensor			
42619	Liso	10	26,90
<ul style="list-style-type: none"> - Base metal - cubierta cristal. - 220-240V , 2X27. - IP20. - Bajo consumo max. 2x25W. - Sensor de movimiento 360° - Sensor de luz 2 a 240 lux. - Temperatura de trabajo -20°C a +50°C. - Tiempo 15 a 270 seg. - Medidas: 300mm. 			



Código	Modelo		Precio tarifa
Aplique MD. AQUA E27			
42235	Blanco	18	8,90
42236	Negro	18	8,90

- 230V - 50Hz E27

Aplique MD. AQUA LED **18W**

42228	Blanco	18	24,90
42229	Negro	18	24,90

Aplique MD. AQUA LED **22W**

42233	Blanco	18	26,90
42234	Negro	18	26,90

- 230V - 50Hz. Lumenes - 1400 y 1700
 - Medidas: 228X228x97.



Apliques de uso interior/exterior



Código	Modelo		Precio tarifa
Aplique REDONDO LED 12W			
42750	Blanco	6	24,50

- Carcasa en polipropileno.
- Medidas: 220X98mm.
- IP54. LUZ 4.000K.
- **900 Lumens.**

Presentación en caja a color.



Aplique **OVAL LED 12W**

42752	Blanco	6	24,50
-------	--------	---	--------------

- Carcasa en polipropileno.
- Medidas: 240X160X96mm.
- IP54. LUZ 4.000K.
- **900 Lumens.**

Presentación en caja a color.



Aplique red. LED 18W 1200 Lm.

42616	Blanco	5	34,60
-------	--------	---	--------------

- Carcasa en polipropileno.
- IP42.
- Luz 4.000K.
- Medidas: 260mm.
- Medidas: 300mm.

- Presentación en caja a color.
- Kit completo





6W



8W



12W

Código	Modelo		tarifa	
--------	--------	---	--------	--

Aplique led 6W 4000K

42760	Liso	30	29,90	
42761	Rejilla	30	29,90	

- Cuerpo de aluminio .
- Medidas: 145x53mm.



Aplique led 8W 4000K

42762	Liso	20	32,90	
-------	------	----	-------	--

- Cuerpo de aluminio .
- Medidas: 211x130X57mm.



Aplique led 8W 4000K

42763	Rejilla	20	32,90	
-------	---------	----	-------	--

- Cuerpo de aluminio .
- Medidas: 211x130X57mm.



Aplique led 12W 4000K

42764	Liso	20	42,90	
-------	------	----	-------	--

- Cuerpo de aluminio .
- Medidas: 200X67mm.



Aplique led 12W 4000K

42765	Rejilla	20	42,90	
-------	---------	----	-------	--

- Cuerpo de aluminio .
- Medidas: 220X67mm.



PANTALLAS ILUMINACIÓN

INTERIOR

EXTERIOR

TECHO/PARED

VARIEDAD

PRÁCTICOS





Código	Modelo	Medidas	Lúmenes		Color		Precio Tarifa
PANTALLA ESTANCA SMD LED			CUERPO DE PC + DIFUSOR DE ABS				
43418	18W	600X82X47mm	1600		6400K	10	17,90
43436	36W	1200X82X47mm	3300		6400K	10	32,60
43445	48W	1500X82X47mm	4200		6400K	10	45,70



CON SENSOR

CAPACIDAD DE INTERCONEXIONADO MAX. 300W

Código	Modelo	Medidas	Lúmenes	Nº LEDS	Color		Tarifa		
PANTALLA ESTANCA SMD LED C/SENSOR			CUERPO DE PC + DIFUSOR DE ABS						
43476	18W	600X86X65mm	1350	SMD 280	6000K	6	79,60		
43477	36W	1200X86X65mm	2750	SMD 560	6000K	6	138,90		



Código	Modelo	Medidas	Lúmenes	Nº LEDS	Color		Tarifa	
PANTALLA ESTANCA IP 65 SMD LED		DIFUSOR DE PC						
43478	20W	600X73X70mm	1327	SMD 280	6400K	10	28,60	
43479	40W	1200X73X70mm	2654	SMD 560	6400K	8	42,60	



Código	Modelo	Medidas	Lúmenes		Color		Tarifa		
PANTALLA ESTANCA PARA TUBO LED			CUERPO DE PC + DIFUSOR DE ABS						
43481	9W	600X70X70mm	800		6000K	18	17,40		
43482	18W	1200X70X70mm	1700		6000K	12	25,90		
43483	24W	1500X70X70mm	2150		6000K	12	41,50		



PANTALLA ESTANCA PARA TUBO LED			CUERPO DE PC + DIFUSOR DE ABS					
43484	2X9W	600X105X70mm	1600		6000K	10	25,90	
43485	2X18W	1200X105X70mm	3400		6000K	8	39,90	
43486	2X24W	1500X105X70mm	4300		6000K	8	68,50	



Alto factor



Alto factor



Código		Medida a		Precio € Tarifa	
Pantalla estanca alto factor G13 - T8 - IP65					
43518	1X18	660 mm.	6	23,20	
43536	1X36	1270 mm.	6	31,60	
43558	1X58	1570 mm.	6	38,90	

- Medida c y b 90 y 100mm.
- Base fabricada en ABS y policarbonato irrompible.
- Reflector metálico lacado en blanco.
- Accesorios de cierre y sujeción en policarbonato irrompible.
- Juntas de neopreno.
- Cables de sujeción a la apertura.

Pantalla estanca alto factor G13 - T8 - IP65					
43618	2X18	660 mm.	8	29,40	
43636	2X36	1270 mm.	4	45,60	
43658	2X58	1570 mm.	4	54,50	

- Medida c y b 135x100mm.

Pantalla estanca electrónica G13 - T8 - IP54					
43660	1X18	660 mm.	6	19,90	
43661	1X36	1270 mm.	6	29,10	
43662	2X18	660 mm.	6	26,10	
43663	2X36	1270 mm.	6	36,00	

- Medida c y b 100x100mm. Para la de un tubo.
- Medida c y b 140x100mm. Para la de dos tubos.
- Fabricada en polipropileno.

Medidas

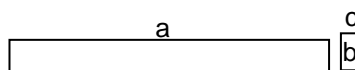

Fabricación nacional



Fabricación nacional



Código	Medidas a 			Precio € Tarifa		
Regleta G13 - T8 - IP20 clase 1					Cajas completas	
43118	1X18	624 mm.	6	17,90		
43136	1X36	1233 mm.	6	19,90		
43158	1X58	1534 mm.	6	24,90		

- Medida c y b 60x83mm.

**TASA ECO-RAEE = 0,50 €
Incluída en el precio**

Regleta G13 - T8 - IP20 clase1					Cajas completas	
43218	2X18	624 mm.	6	19,90		
43236	2X36	1233 mm.	6	29,80		
43258	2X58	1534 mm.	6	37,90		

- Medida c y b 136x41mm, Sin tubo.
- IP20.

**TASA ECO-RAEE = 0,50 €
Incluída en el precio**



Regleta G13 - T8 - IP20 clase1					Cajas completas	
HL150	1X18	624 mm.	12	12,90		

- Medida c y b 60x83mm.

**TASA ECO-RAEE = 0,50 €
NO incluída en el precio**

Regleta G13 - T8 - IP20 clase1					Cajas completas	
HL151	2X18	624 mm.	12	14,80		

- Medida c y b 136x41mm, Sin tubo.
- IP20.

**TASA ECO-RAEE = 0,50 €
Incluída en el precio**

Mini regleta G13 - T8 - IP20 clase1					Cajas completas	
HL160	1X18	720 mm.	5	6,40		
HL161	1X36	1330 mm.	5	8,40		

- Medida c y b 50x52mm.

Mini regleta G13 - T8 - IP20 clase1					Cajas completas	
HL162	2X18	720 mm.	6	10,40		
HL163	2X36	1330 mm.	6	14,80		

- Medida c y b 40x73mm.

Mini regleta G13 - T8 - IP20 clase1					Cajas completas	
HL164	1X18	690 mm.	6	6,40		
HL165	1X36	1300 mm.	6	8,40		

- Medida c y b 50x38mm.

Todos los aparatos completos 220-240V, 50-60 Hz (Sin tubos)



**CAJAS
COMPLETAS**

Tubos incluidos

- Tubo T8 / 220-240V / 50-60Hz.
- Transformador electrónico.
- Medidas: 638X104X42mm.
- Medidas: 1248X130X56mm.



Código	W		Precio € Tarifa	
Regleta electrónica con rejilla metálica				
45617	1 X 36	6	34,80	

Tubos incluidos



Mini Regleta de tubo T5 con interruptor.

45628	8W	6	13,60	
45629	13W	6	16,20	
HL200118	21W	6	19,60	

- Tubo T5 220-240V / 50-60Hz.
- Especial bajo muebles, etc .
- Medidas: 340-572-900-1200-X42X22mm.
- **1,8 mt. de cable.**
- **Clavija para conectar.**
- **20 cm. de conexión para conectar entre ellas.**





Regleta de Led, 220-240V / 50-60 Hz. Luz 6400k

Código	Vatios	Medidas	Lumen		Precio €
45210	18 W	600X70X27 mm.	1135	6	17,90
45211	36 W	1200X70X27 mm.	2269	6	26,60

REGLETA LED

tubo visto

Equipo incluido



NUEVAS MEDIDAS



Regleta mod-T5 no enlazable entre si con toma de corriente solo en un extremo **4000K**

MARCA HEPOLUZ

45666	5W	296X23X33mm.	380	12	7,90
-------	----	--------------	-----	----	------

Regleta mod-T8 no enlazable entre si con toma de corriente solo en un extremo **4000K**

MARCA HEPOLUZ

45663	9W	600X30X36mm.	800	12	13,90
45665	20W	1200X30X36mm.	1800	6	15,90

Regleta mod-T8 enlazable entre si con toma de corriente en ambos extremos + interruptor **6400K**

MARCA HOROZ

45200	5W	296X23X33mm.	540	6	10,90
45205	9W	600X30X36mm.	810	6	15,90
45206	12W	900X30X36mm.	1080	6	17,90
45207	16W	1200X30X36mm.	1440	6	19,90



LED

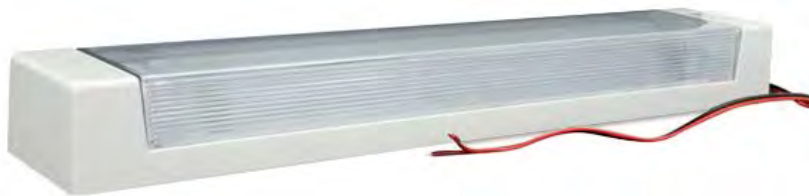

LED



Incluye conector



Cable conexión de 1,8 mts.

Código	Wat		Precio € Tarifa
--------	-----	---	--------------------

Regleta de emergencia

438010	2 X 8	12	34,90
--------	-------	----	-------

- Tubo 2 X 8W T5 / 220-240V / 50-60Hz.
- Batería recargable 6V 4Ah
- Autonomía: 90 minutos.
- Medidas: 400x70x60mm.
- Tubos incluidos



Regleta de emergencia

438037	35 Led	6	42,40
--------	--------	---	-------

- 35 led / 220-240V / 50-60Hz.
- Batería. recargable 6V 2,8Ah
- Autonomía: 5 horas
- Medidas: 290x80x70mm.



Regleta de 12V con interruptor.

4502040	1 X 8	12	22,10
---------	-------	----	-------

- Tubo de 8W. T5 12V
- Especial barcos, caravanas etc.
- Medidas: 400X70X60



Regleta de led 3W con interruptor.

45660	3 X 1	6	69,40
-------	-------	---	-------

- 3 Led de 1W. 220-240V / 50-60Hz
- Especial bajo muebles etc.
- Con cable y clavija de 1,8 mts.
- Medidas: 430X53X26





IP20



IP20

LED



fabricación
NACIONAL



IP44

LED



Precio €

Código	W	Lm.	m ²		Tarifa	
Luces de emergencia						
HL306	6	70	14	10	19,40	
HL308	8	103	20	10	20,90	

- Tubo T5 / 220-240V / 50-60Hz.
- Batería. 2 x 4V 0,9Ah recargable
- Autonomía: 90 minutos.
- 1 x 6-Medidas: 245 x 75 x 45mm.
- 1 x 8-Medidas: 325 x 75x 45mm.

HL306L	1,8	90	14	10	22,60	
HL308L	2,4	120	20	10	26,40	

- Leds 18 x 1500MCD 110°
- Leds 24 x 1500MCD 110°
- 220-240V / 50-60Hz.
- Batería. 2 x 4V 0,9Ah recargable.
- Autonomía: 5 HORAS
- Medidas; 245 x 75 x 45mm.
- Medidas: 325 x 75 x 45mm.

Luces de emergencia LED

43710	1	60		20	29,40	
43712	2	150		20	39,40	
43714	3,7	300		20	54,30	

- Diseñada según norma. UNE EN 60598-2-22, y UNE-EN 60598-1, 62031 y 62384
- Grado de protección IP44 - IK 04
- Grado de protección II.
- Led indicador de presencia de red y carga de batería
- Batería de NI-Cd estanca, de alta temperatura
- Medidas: 255X89X37

Útil para empotrar serie Led

43720				10	6,40	
-------	--	--	--	----	------	--

Medida empotrar: 278X115X36



Código	Color		Precio
Flexo estudio Md-Capri lámpara PL G23 11W			
HL069G	Gris	6	28,60
HL069B	Blanco	6	28,60
HL069N	Negro	6	28,60

- Lámpara incluida.
- Sobremesa o fijado con accesorio.



Flexo estudio 220V E27 -máx. 60W

HL050B	Blanco	12	14,80
HL050N	Negro	12	14,80
HL050R	Rojo	12	14,80

- Medidas: Campana 120mm.
 Altura 350mm.
 Base 130 mm.



Flexo estudio Md-Tango

Lámpara estándar E27 máx..60W

44192	Blanco	6	25,90
HL074N	Negro	6	25,90
HL074R	Rojo	6	25,90

Lámpara no incluida.





Código	Color		Precio
Flexo estudio con pinza			
HL067B	Blanco	12	15,50
HL067N	Negro	12	15,50
HL067R	Rojo	12	15,50

- 220 - 240V
- E27
- MAX. 60W
- Medidas: 300X120.



Flexo estudio		10W LED	
44206	Blanco	6	82,10
44207	Negro	6	82,10
44208	Plata	6	82,10

- 220 - 240V / 50-60 Hz.
- 10w - 600 lm.
- Control de funcionamiento.
- 3 tonos de luz diferentes (2700-4600-6400K)
- Dimable.
- Totalmente articulado, cabezal giratorio.
- Medidas: 500X360.
- Incluye gancho de sujecion para fijar en la mesa.



Flexo lectura 8 led			
04002910	Plata	4	7,50

- Funciona con 3 baterías R03 incluidas.





Código	Color		Precio
			5W LED
44203	Azul	12	53,60
44204	Amarillo	12	53,60
44205	Rosa	12	53,60

- 220 - 240V / 50-60 Hz.
- 5w - 300 lm. 4600K
- Control de funcionamiento (3 funciones: 100% -50% - off)
- Totalmente articulado, cabezal giratorio.
- Reloj con funcionamiento a baterias con boton de extracción.
- Medidas: 400X300.



			5W LED
Código	Color		Precio
44210	Blanco	12	49,20
44211	Negro	12	49,20
44212	Rojo	12	49,20

- 220 - 240V / 50-60 Hz.
- 5w - 300 lm. 4600K
- Control de funcionamiento tocando la base.(3 funciones: 100% -50% - off)
- Totalmente articulado, cabezal giratorio.
- Medidas: 420X330.





Código	Modelo		Precio €
Portátil goma metal máx.60W			
44974	5 mts.	6/24	11,90
44976	10 mts.	6/24	16,80

- Cable manguera H-05 VV-F de 2X1 mm².
- Fabricadas bajo norma UNE EN60598-2-8.



Portátil goma metal máx.100W			
44953	5 mts.	6	15,80

- Cable manguera H-05 VV-F de 2X0,75 mm².
- Fabricadas bajo norma UNE EN60598-2-8.



Portátil goma metal máx.200W			
44958	10 mts.	6	26,90

- Cable manguera H-05 VV-F de 2X0,75 mm².
- Fabricadas bajo norma UNE EN60598-2-8.





Imanes

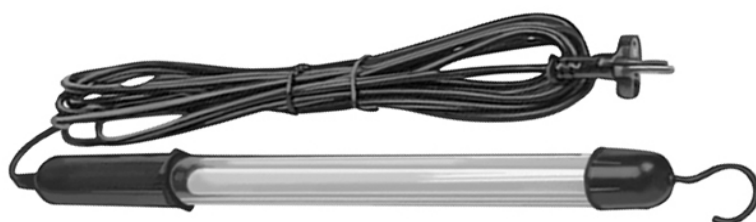

Código	Modelo		Precio €
Portátil 60 LED			
44963	60 leds	6	34,60

- Recargable portátil .
- Con transformador 110 / 220V a 12V.
- Clavija directa a mechero del coche.
- Tiempo de carga 3 horas.
- Autonomía de 5-6 horas.

Portátil tubo 8W

44970	tubo	6	9,90
-------	------	---	------

- Cable de 5 mts. 12V



Portátil tubo 8W

44961	tubo	6	13,60
-------	------	---	-------

- Cable de 5 mts. 230V





Código	Modelo		Precio €
--------	--------	---	----------

Pica jardín

4560690	una	10	14,80
---------	-----	----	-------

- Cable H05RN-F 2X1 2 M.



Pica jardín

45082	una	10	12,90
-------	-----	----	-------

- Cable 1'8 MTS.E27.



Pica jardín con dos bases schucko 16A 250V

45026	1,5 mts.	6	9,90
-------	----------	---	------

- Cable de H07RN-F 3G 1,5mm.
 - Máx. 3.500W.





Código	Modelo		Precio tarifa
Appliques halógenos G9 40W 220-240V 50Hz.			
HL743	1 luz	48	13,40

- Color cromo mate.
- Lámpara dicroica G9 40W (incluida).
- Medida base 70mm.



Appliques halógenos G9 40W 220-240V 50Hz.			
HL744	2 luces	24	28,60

- Color cromo mate.
- Lámpara dicroica G9 40W (incluida).
- Medida largo 275mm.



Appliques halógenos G9 40W 220-240V 50Hz.			
HL745	3 luces	20	42,80

- Color cromo mate.
- Lámpara dicroica G9 40W (incluida).
- Medida largo 445mm.



Appliques halógenos G9 40W 220-240V 50Hz.			
HL747	3 luces	24	37,20

- Color cromo mate.
- Lámpara dicroica G9 40W (incluida).
- Medida largo 180mm.



Código	Lumenes		Tarifa
Aplique COB LED 4W 220-240V 50Hz.			
HL7181L	260	48	39,20

- Color cromo.
- Luz: 3.000°K.
- IP20.

1 LED = 4W

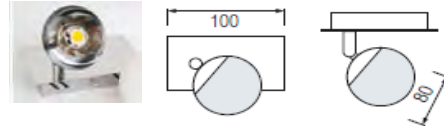

Apliques COB LED 2X4W 220-240V 50Hz.

HL7182L	520	24	69,40
---------	-----	----	-------

- Color cromo.
- Luz: 3.000°K.
- IP20.

2 LED = 8W

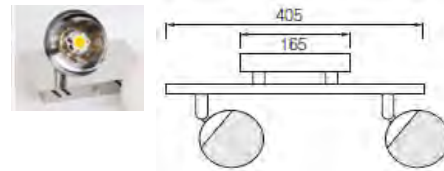

Apliques COB LED 3X4W 220-240V 50Hz.

HL7183L	780	20	99,80
---------	-----	----	-------

- Color cromo.
- Luz: 3.000°K.
- IP20.

3 LED = 12W

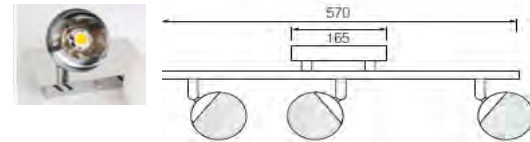

**LED
COB**

Lámpara pendular LED 12W

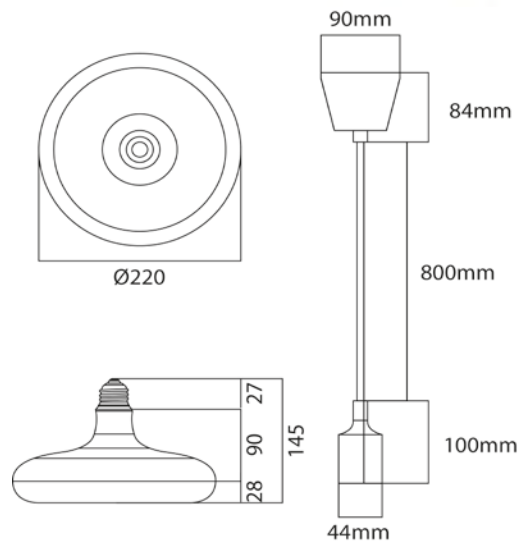

Código	Color	Lumens		Precio € Tarifa	
Lámpara pendular LED 12W E27 6400K					
42740	Blanca	850	10	36,90	
42741	Negra	850	10	36,90	
42742	Roja	850	10	36,90	
42743	Azul	850	10	36,90	



Foto	Código	Medidas	Color		Precio € tarifa
Aros en aluminio para lamparas 50mm.					
	47201	80X25	Blanco	100	3,80
	47202	80X25	Níquel mate	100	4,50
	47203	80X25	Cromo	100	4,50
	47210	85X25	Cromo	100	4,70
	47211	85X25	Cromo mate	100	4,70
	47212	85X25	Antiq. Cobre	100	4,70
	47220	85X25	Cromo	100	4,70
	47221	85X25	Cromo mate	100	4,70
	47222	85X25	Antiq. Cobre	100	4,70

Medidas de corte 70 mm.





Código	Color	Medida		Precio €
Downlight aluminio para 2X26W				
47840	Blanco	230 mm.	6	28,40
47845	Níquel	230 mm.	6	32,40

Lámparas incluidas.



Downlights redondo en aluminio inyectado

47899	Níquel	165 mm.	6	29,80
-------	--------	---------	---	-------

- Con balastro electrónico digital.
- Para 2 lámparas PL-G24Q3 de 13W.

Lámparas incluidas.



Downlights aluminio para 2 X E27

47430	Blanco	158X90 mm	6	15,40
-------	--------	-----------	---	-------

- Usan 2 lámparas bajo consumo E27 (no incluidas).



Downlights para 2 G24 2 pin (Especial lám.leds)

47885	Blanco	225 mm.	6	16,40
-------	--------	---------	---	-------

- Medida exterior ancho 225mm. Altura 90mm.
- Usa 2 lámparas LEDS G24 2 pins (no incluidas).



5W



5W



5W



Código	Color	Luz	Lumen		Precio €
Aro led 5W con equipo 220-230V - 50Hz.					
46015	Blanco	2700K	354	10/50	15,90
46016	Blanco	6500K	354	10/50	15,90
46017	Niquel	2700K	354	10/50	15,90
46018	Niquel	6500K	354	10/50	15,90

- Medida exterior ancho 90mm.
- Altura 60mm.
- Medidas de corte: 75mm.

**COB
LED**

CUERPO DE ALUMINIO

Aro led 5W con equipo 220-230V - 50Hz.

46010	Blanco	2700K	354	10/50	15,90
46011	Blanco	6500K	354	10/50	15,90
46012	Niquel	2700K	354	10/50	15,90
46013	Niquel	6500K	354	10/50	15,90

- Medida exterior ancho 90mm.
- Altura 60mm.
- Medidas de corte: 75mm.

**COB
LED**

CUERPO DE ALUMINIO

Aro led ECO 5W con equipo 220-230V - 50Hz.

46020	Blanco	2700K	325	10/50	6,90
46021	Blanco	6500K	325	10/50	6,90
46022	Niquel	2700K	325	10/50	6,90
46023	Niquel	6500K	325	10/50	6,90





- Medida exterior ancho 83mm.
- Altura 40mm.
- Medidas de corte: 70mm.

**COB
LED**

CUERPO DE HIERRO





Código		Medidas	Luz	Color	Lumen	watios		Tarifa	
Downlight aluminio		220-240V 50-60Hz.			Grados apertura 120°				
46055		150X50	6400K	Blanco	550	10W	20	14,20	
46057		150X50	6400K	Cromo Mt.	550		20	14,20	
46059		180X60	6400K	Blanco	650	15W	20	16,40	
46061		180X60	6400K	Cromo Mt.	650		20	16,40	
46062		220X70	3000K	Blanco	1312	25W	10	23,40	
46063		220X70	6400K	Blanco	1312		10	23,40	
46065		220X70	6400K	Cromo Mt.	1312		10	23,40	

- Marca de LED: ETI
- Temperatura de trabajo: -20 + 50.
- Protección clase II. IP20
- Compatibilidad electromagnética WEEE Aprobado.



PANEL LED EXTRAFINO

Los paneles LED proporcionan una proyección uniforme de la luz. Ideal para uso en techos de hogares, despachos locales comerciales y diversas estancias.

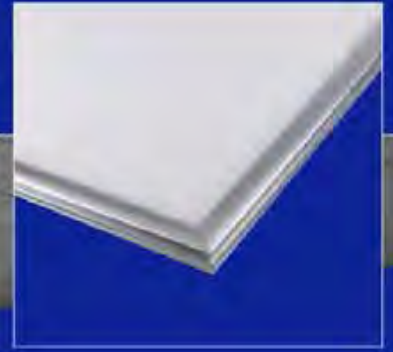

Extrafinos,
brillantes
y modernos



Código	Color	Lumen		Precio €
--------	-------	-------	---	----------

Panel LED Extrafino BLANCO

47973	6000K	1280	40	14,20
-------	-------	------	----	-------

- Cuerpo aluminio inyectado.
- 220-240V - IP20.
- Medidas: 225mm. diamet. total, altura 15mm.
- Medidas de corte. 210mm.

Panel LED Extrafino NIQUEL

47975	6000K	1280	40	21,80
-------	-------	------	----	-------

- Cuerpo aluminio inyectado.
- 220-240V - IP20.
- Medidas: 225mm. diamet. total, altura 15mm.
- Medidas de corte. 200mm.

Panel LED Extrafino BLANCO

47964	4000K	1550	20	17,60
47963	6000K	1650	20	17,60

- Cuerpo aluminio inyectado.
- 220-240V - IP20.
- Medidas: 223mm. diamet. total, altura 15mm.
- Medidas de corte. 210mm.

Panel LED Ultra slim BLANCO

47977	4000K	2600	10	43,80
47978	6000K	2600	10	43,80

- Cuerpo aluminio inyectado.
- 220-240V - IP20.
- Medidas: 220mm. diamet. total, altura 10mm.
- Medidas de corte. 185mm.

PANEL LED EXTRAFINO

Los paneles LED proporcionan una proyección uniforme de la luz. Ideal para uso en techos de hogares, despachos locales comerciales y diversas estancias.

Extrafinos,
brillantes
y modernos

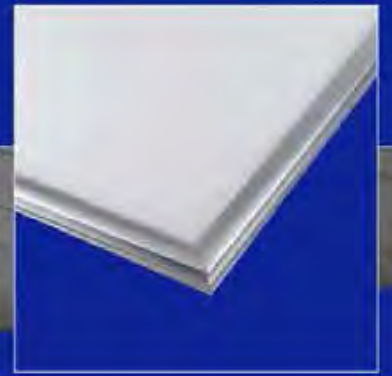

36W

NUEVO



52W

SMD
LED



COD. 4798S



COD. 4798M



SOLO PARA PANELES DE 52W COD - 47984 Y 47985

Código	Color	Lumen		Precio €
--------	-------	-------	--	----------

Panel LED
PARA TECHO ASTRONG 36W

47987	6000K	2700	5	66,00
-------	-------	------	---	-------

- Cuerpo aluminio
- 220-240V - IP20.
- Medidas: 595X595X10mm.

Panel LED
PARA TECHO ASTRONG O SUPERFIE 52W

47984	4000K	4250	5	118,20
-------	-------	------	---	--------

47985	6000K	4500	5	118,20
-------	-------	------	---	--------

- Cuerpo aluminio inyectado.
- 220-240V - IP20.
- Medidas: 595X595X10mm.

4798S	S.superf.		1	6,90
-------	-----------	--	---	------

4798M	Empotrar		1	6,90
-------	----------	--	---	------

CON LOS SOPORTES
ES POSIBLE REALIZAR UNA
INSTALACIÓN
DE SUPERFICIE









Código	Medidas	Medidas			wattios	Grados apertura 120°	Precio € tarifa
		corte	Luz	Lumen			
Downlight opal de Led		220-240V 50-60Hz.			Grados apertura 120°		
46167	90X25	70	3000K	110	3W	40	4,48
46168	90X25	70	4200K	110		40	4,48
46169	90X25	70	6400K	110		40	4,48
46170	120X25	105	3000K	270	6W	40	7,44
46171	120X25	105	4200K	270		40	7,44
46172	120X25	105	6400K	270		40	7,44
46173	150X25	135	3000K	540	9W	40	8,63
46174	150X25	135	4200K	540		40	8,63
46175	150X25	135	6400K	540		40	8,63
46176	170X25	155	3000K	660	12W	20	10,98
46177	170X25	155	4200K	660		20	10,98
46178	170X25	155	6400K	660		20	10,98
46179	195X25	170	3000K	900	15W	20	12,24
46180	195X25	170	4200K	900		20	12,24
46181	195X25	170	6400K	900		20	12,24
46182	225X25	205	3000K	1170	18W	20	13,59
46183	225X25	205	4200K	1170		20	13,59
46184	225X25	205	6400K	1170		20	13,59
46186	300X25	285	4200K	1632	24W	10	29,55
46187	300X25	285	6400K	1632		10	29,55
Pantallas Led		220-240V 50-60Hz.			Grados apertura 120°		
46201	595x595x10,5	285	3000K	1800	32W	10	50,43
46202	595x595x10,5	285	6400K	2000		10	50,43

- Tipo de LED SMD, 40x14. Marca de LED: ETI
- Temperatura de trabajo: -20 + 40.
- Protección clase II. IP20
- Compatibilidad electromagnética WEEE Aprobado.
- EMC Aprobado.





Código		Medidas	Luz	Lumen	watios		Precio € tarifa	
Downlight Led opal		220-240V 50-60Hz.			Grados apertura 120°			
46150		180X40	3000K	840	12W	20	14,40	
46151		180X40	4200K	840		20	14,40	
46152		180X40	6400K	840		20	14,40	
46153		225X40	3000K	1300	18W	20	17,70	
46154		225X40	4200K	1300		20	17,70	
46155		225X40	6400K	1300		20	17,70	
46156		300X40	3000K	1960	28W	20	28,60	
46157		300X40	4200K	1960		20	28,60	
46158		300X40	6400K	1960		20	28,60	
46206		400X40	4200K	2240	32W	5	49,50	
46209		500X40	4200K	2800	40W	5	78,20	
46212		600X40	4200K	3360	48W	5	92,40	





- Marca de LED: ETI
- Temperatura de trabajo: -20 + 50.
- Protección clase II. IP20
- Compatibilidad electromagnética WEEE Aprobado.

WEEE
WASTE ELECTRICAL AND ELECTRONIC EQUIPMENT

CE







Código		Medidas	Luz	Lumen	watios		Precio € Tarifa	
Downlight Led opal SUPERFICIE		220-240V 50-60Hz.		Grados apertura 120°				
46159		180X40	3000K	840	12W	20	14,40	
46160		180X40	4200K	840		20	14,40	
46161		180X40	6400K	840		20	14,40	
46162		225X40	3000K	1300	18W	20	17,70	
46163		225X40	4200K	1300		20	17,70	
46164		225X40	6400K	1300		20	17,70	
46165		300X40	3000K	1960	28W	20	28,60	
46166		300X40	4200K	1960		20	28,60	
46188		300X40	6400K	1960		20	28,60	

- Marca de LED: ETI
- Temperatura de trabajo: -20 + 50.
- Protección clase II. IP20
- Compatibilidad electromagnética WEEE Aprobado.



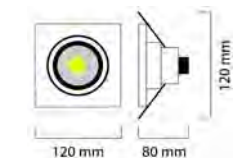
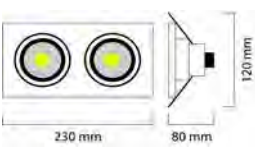
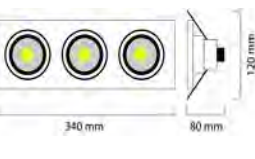

Código		Medidas	Luz		Lumen	watios		Precio € tarifa
Apliques led de 1, 2, ó 3 elementos			220-240V 50-60Hz.		Grados apertura 120°			
HL6711L		120X80	6400K	Blanco	539	10W	10	36,90
HL6712L		230X120X80	6400K	Blanco	2X539	20W	10	68,40
HL6713LC		340X120X80	3000K	Blanco	3X539	30W	10	96,60
HL6713L		340X120X80	6400K	Blanco	3X539		10	96,60
46070		235X100	6400K	Blanco	1447	30W	20	77,40

- Marca de LED: ETI
- Temperatura de trabajo: -20 + 50.
- Protección clase II. IP20
- Compatibilidad electromagnética WEEE Aprobado.





**SMD
LED**

PROYECTORES SMD LED

IP65



PROYECTORES SMD LED **ULTRASLIM**



Código	Wattios	Lumenes		Precio tarifa
Proyector SMD led ultra slim 6000K IP65				
49657	22W	1690	6	34,90

Medidas: 190x22x145mm

Proyector SMD led ultra slim 6000K IP65

49659	32W	2540	6	47,90
-------	-----	------	---	--------------

Medidas: 220x22x175mm

Proyector SMD led ultra slim 6000K IP65

49661	52W	4250	4	65,90
-------	-----	------	---	--------------

Medidas: 220x22x185mm



ultraSLIM
 GROSOR 2,3CM



Proyector SMD LED 6.000°K IP65
 - Lumens: 700
 - Medidas: 135X115X39mm.

Código		P.V.
49651	50	11,95



Proyector SMD LED 6.000°K IP65
 - Lumens: 1400
 - Medidas: 182x141x47 mm.

Código		P.V.
49652	30	21,20



Proyector SMD LED 6.000°K IP65
 - Lumens: 2000
 - Medidas: 225x185x54 mm.

Código		P.V.
49653	20	27,50



Proyector SMD LED 6.000°K IP65
 - Lumens: 3400
 - Medidas: 285x232x62 mm.

Código		P.V.
49654	15	43,60



Proyector SMD LED 6.000°K IP65
 - Lumens: 6900
 - Medidas: 337x289x62 mm.

Código		P.V.
49655	5	78,90



Proyector SMD LED 6.000°K IP65
 - Lumens: 10900
 - Medidas: 337X289X62 mm.

Código		P.V.
49656	4	110,00



PROYECTORES COB LED

IP65



COB LED



Proyector 10W COB LED IP65

- Lumens: 700.
- Luz: 4.000°K
- Medidas: 85X111mm.



Proyector 20W COB LED IP65

- Lumens: 1.400.
- Luz: 4.000°K
- Medidas: 140x180mm.



c/sensor

Proyector 20W COB LED IP65

- Lumens: 1.400.
- Luz: 4.000°K
- Medidas: 1.800x190mm.

Código



P.V.

49645

20

14,90

Código



P.V.

49646

12

29,90

Código



P.V.

49615

4

64,90



Proyector 30W COB LED IP65

- Lumens: 2.000.
- Luz: 4.000°K
- Medidas: 200x220mm.



Proyector 50W COB LED IP65

- Lumens: 3.400.
- Luz: 4.000°K
- Medidas: 230x280mm.



Proyector 100W COB LED IP65

- Lumens: 6.900.
- Luz: 4.000°K
- Medidas: 350X260mm.

Código



P.V.

49647

8

44,20

Código



P.V.

49648

4

59,60

Código



P.V.

49649

4

110,40

COB LED



Proyector 150W COB LED IP65

- Lumens: 11.250.
- Luz: 4.000°K
- Medidas: 325x425mm.

Código		P.V.
49650	4	124,90



Proyector 300W COB LED IP65

- Lumens: 22.500.
- Luz: 6.000°K
- Medidas: 345X525mm.

Código		P.V.
49668	1	325,00



Proyector 400W COB LED IP65

- Lumens: 30.000.
- Luz: 6.000°K
- Medidas: 355X630mm.

Código		P.V.
49669	1	395,00

20W

**LED
VERDE**

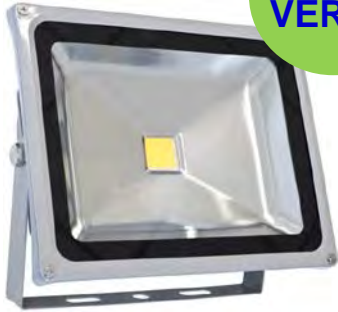

ESPECIAL GARDEN

Proyector SMD LED 6.500°K IP65
 - Lumens: 1400

Código		P.V.
49617	4	29,90

30W



Proyector SMD LED 6000°K IP65
 - Lumens: 1850
 - 3 metros de manguera RN 3X1

Código		P.V.
49640	4	43,20

30W

**CON
SOPORTE**



Proyector SMD LED 6000°K IP65
 - Lumens: 1850
 - 3 metros de manguera RN 3X1

Código		P.V.
49642	4	49,60

50W

**CON
SOPORTE**



Proyector SMD LED 6000°K IP65
 - Lumens: 3,400
 - 3 metros de manguera RN 3X1

Código		P.V.
49643	2	71,40

30W

**CON
SOPORTE**



RECARGABLE
 duración de batería aprox. 8 hr.

Proyector COB LED 4000°K IP65
 - 30W Lumens: 2100
 - Cargador a 220V y a 12V toma de encendedor
 - Estribo de fijación

Código		P.V.
49639	6	162,00

10W



Proyector SMD LED 6.500°K IP65
 - Lumens: 500
 - Medidas: 150X126X35mm.

Código		P.V.
49750	10	10,90

20W



Tambien en Verde

Proyector SMD LED 6.500°K IP65
 - Lumens: 1000
 - Medidas: 182x151x36 mm.

Código		P.V.
49751	5	18,90
49745	5	18,90

30W



Proyector SMD LED 6.500°K IP65
 - Lumens: 1.500
 - Medidas: 229x182x37 mm.

Código		P.V.
49752	5	26,80

50W



Proyector SMD LED 6.500°K IP65
 - Lumens: 2.500
 - Medidas: 374x118x38,5 mm.

Código		P.V.
49753	5	39,90

100W



Proyector SMD LED 6.500°K IP65
 - Lumens: 5000
 - Medidas: 395x308x70 mm.

Código		P.V.
49754	5	77,80

200W



Proyector SMD LED 6.500°K IP65
 - Lumens: 10000
 - Medidas: 480X430X102 mm.

Código		P.V.
49755	5	179,00

70W



Proyector SMD LED 6.500°K IP65
 - Lumens: 5600
 - Medidas: 240X215X85

Código		P.V.
49766	5	109,70

100W



Proyector SMD LED 6.500°K IP65
 - Lumens: 8000
 - Medidas: 290X230X90

Código		P.V.
		198,60

Código		P.V.
49767	5	198,60

CON SENSOR

10W



Proyector SMD LED 6.400°K IP65
 - Lumens: 500
 - Medidas: 150X186X62mm.

Código		P.V.
49758	10	29,20

CON SENSOR

20W



Proyector SMD LED 6.400°K IP65
 - Lumens: 1000
 - Medidas: 182x208X62mm.

Código		P.V.
49759	5	39,20

CON SENSOR

30W



Proyector SMD LED 6.400°K IP65
 - Lumens: 1500
 - Medidas: 225X240X62mm.

Código		P.V.
49760	5	46,20

CON SENSOR

50W



Proyector SMD LED 6.400°K IP65
 - Lumens: 2500
 - Medidas: 274X274X63mm.

Código		P.V.
49761	5	59,30

CON SENSOR

100W



Proyector SMD LED 6.400°K IP65
 - Lumens: 5000
 - Medidas: 395X365X110mm.

Código		P.V.
49762	5	119,00

CON SENSOR

10W



- 220-240V-50-60Hz.
 - IP 65.
 - Luz 6500K
 - 10W. 520 Lumenes
 - Medidas: 150X170X50 mm.

Código		P.V.
HL171L	5	59,90

SERIE INDUSTRIAL Md. Leopard



Proyector SMD LED IP65

- Lumens: 1700
- Medidas: 157X180mm.

Proyector SMD LED IP65

- Lumens: 2550
- Medidas: 171x195mm.

Proyector SMD LED IP65

- Lumens: 4250
- Medidas: 202x243mm.

Código		P.V.
49782 4200K	24	32,00
49783 6500K	24	32,00

Código		P.V.
49798 3000K	20	42,00
49784 4200K	20	42,00
49785 6500K	20	42,00

Código		P.V.
49786 4200K	10	58,00
49787 6500K	10	58,00



Proyector SMD LED IP65

- Lumens: 8500
- Medidas: 253x280mm.

Proyector SMD LED IP65

- Lumens: 12750
- Medidas: 310x345mm.

Proyector SMD LED IP65

- Lumens: 17000
- Medidas: 310x345 mm.

Código		P.V.
49788 4200K	5	106,00
49789 6500K	5	106,00

Código		P.V.
49790 4200K	5	148,00
49791 6500K	5	148,00

Código		P.V.
49792 4200K	5	192,00
49793 6500K	5	192,00

SERIE INDUSTRIAL Md. Panter



50W



100W



150W

Proyector COB LED IP65 6400K
 - Lumens: 3750
 - Medidas: 245X297mm.

Proyector COB LED IP65
 - Lumens: 7500
 - Medidas: 246x324mm.

Proyector COB LED IP65 6400K
 - Lumens: 11250
 - Medidas: 315x418mm.

Código		P.V.
49771	6	59,00

Código		P.V.
49772 4200K	6	87,00
49773 6400K	6	87,00

Código		P.V.
49775	1	162,00

Proyector COB LED IP65 6400K
 - Lumens: 15000
 - Medidas: 314X418mm.

Código		P.V.
49777	1	176,00

Proyector COB LED IP65 6400K
 - Lumens: 22500
 - Medidas: 345x525mm.

Código		P.V.
49779	1	263,00

Proyector COB LED IP65 6400K
 - Lumens: 30000
 - Medidas: 355x625 mm.

Código		P.V.
49781	1	340,00



200W

300W

400W



Código	Wattios	Color		Precio tarifa
Proyectores halógenos 120W con lámpara.				
49503	120W	negro	6	6,90
49504	120W	blanco	6	6,90

Lámpara incluida.



Proyectores bajo consumo 20W

49702	20W	negro	20	17,90
-------	-----	-------	----	--------------

- Carcasa anticorrosión.
- Protección clase HI, impermeable AIP X4.
- Portalámparas R7s.
- Medidas: 185x140.

Lámpara incluida.

Proyectores bajo consumo 20W

41295	20W	1200 lm	10	12,60
-------	-----	---------	----	--------------





Código	Wattios	Color		Precio tarifa
Proyector halógeno con sensor de mov. 180° e interruptor crepuscular				
49552	120W	Blanco	6	32,40

- Con lámpara y manguera de 3x1.
- H05RN - F. Goma negra 5 mts.
- Portalámparas R7s.

Presentación en caja a color.

49547	120W	Negro	6	22,80
-------	------	-------	---	-------

- Sin cable.

Presentación en caja a color.

Proyector halógeno con sensor de mov.180° e interruptor crepuscular

49557	400W	Blanco	6	36,80
-------	------	--------	---	-------

- Con lámpara y manguera de 3x1.
- H05RN - F. Goma negra 5 mts.
- Portalámparas R7s.

Presentación en caja a color.

Proyector halógeno con sensor de mov. 180° e interruptor crepuscular

49548	400W	Blanco	6	26,40
49549	400W	Negro	6	26,40

- Sin cable.

Presentación en caja a color.



Código	Wattios	Color		Precio tarifa
Proyector bajo consumo cuerpo de aluminio				
77018	100W	Negro	4	17,40 €

- Conexión directa a red 230V 50Hz.
- Portalamparas E27
- Medida exteriores: 247X155.
- Medida interiores: 175X120.
- Medida máx. Lámpara 160X60.
- Lámpara no incluida.

Máx.100W
1xE27

Lámpara no incluida

Proyector bajo consumo cuerpo de aluminio				
77021	200	Negro	4	22,60 €

- Conexión directa a red 230V 50Hz.
- Portalamparas E27
- Medida exteriores: 340X220.
- Medida interiores: 260X180.
- Medida máx. Lámpara 250X100.
- Lámpara no incluida.

Máx.200W
1xE27

Lámpara no incluida



Código	Modelo		Precio tarifa
Set Proyectoros halógenos 2x400w con trípode			
49586	2 Cabezas	2	64,60

- Con 5 mts de cable goma.
- Altura: 1,60 mt.

Soporte proyector suelo

49592		1	15,20
-------	--	---	--------------

- Con 1,50 mts de cable goma.
- Medidas: 170x270 mm.

Trípode extensible

49590	1 Cabeza	1	41,40
-------	----------	---	--------------

- Con 1,80 mts de cable goma.
- Altura: 1,60 mt.

Trípode extensible

49591	2 Cabezas	1	44,80
-------	-----------	---	--------------

- Con 1,80 mts de cable goma.
- Altura: 1,60 mt.



Código	Color	W		Precio €
Proyector de halogenuro metálico, conexión directa.				
49931	Negro	70	6	64,20

- Medidas: 350X230X87mm.
- Usa 1 lámpara halogenuro metálico, R7 (incl).
- Cuerpo de aluminio.
- Para interior y exterior.
- Lumens para la de 70W 5500lm.
- Lumens para la de 150W 12000lm.

Lámparas incluidas.

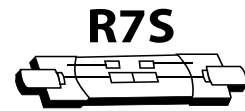

Proyector de halogenuro metálico, conexión directa.

49924	Negro	250	6	178,00
-------	-------	-----	---	--------

- Medidas: 485X410X140mm.
- Usa 1 lámpara halogenuro metálico, E40 (incl).
- Cuerpo de aluminio barnizado color negro.
- Vidrio de seguridad templado transparente.
- Lira de acero.
- Cierre mediante clips muelle inoxidables.
- Junta estanca resistente a altas temperaturas.
- Lumens para la de 250W 22500lm.
- Lumens para la de 400W 36000lm.

Lámparas incluidas.

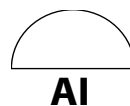



Código	W	Color		Precio
Proyector bajo consumo 3x36w				
49711	3x36	negro	1	132,00 €

- 220-250 V.
- 108W (3x36W), 50-60 Hz.
- Carcasa Policarbonato.
- Estanqueidad IP44.
- 8.200 Lumens.
- Cable de 5 mts. H07RN-F 3G1,5.
- Con 3 bases shucko 230V 16A.
- Medidas: 500x290x110 mm.

Lámparas incluidas.



Proyector bajo consumo 3x24w

49706	3X24	negro	1	112,00 €
-------	------	-------	---	----------

- 220-250 V.
- 72W (3x24W), 50-60 Hz.
- Carcasa Policarbonato.
- Estanqueidad IP44.
- 5.900 Lumens.
- Cable de 5 mts. H07RN-F 3G1,5.
- Con 3 bases shucko 230V 16A.
- Medidas: 415x290x110 mm.

Lámparas incluidas.





Código	W	Color		Precio
Farola calle para lámpara bajo consumo E27				
HL190	60	Blanca	10	41,20

- Portalámparas E27. (No incluye lámpara).
- 220-240V - 50-60 Hz.
- Carcasa policarbonato.
- Estanqueidad IP 65.
- Medidas 345x200x120 mm.

Farola calle SMD LED

HL195L	26	Plata	2	146,00
--------	----	-------	---	---------------

- 220-240V - 50-60Hz.
- Cuerpo aluminio inyectado.
- Lámpara LED 12 SMD.
- Lúmenes: 2250.
- Medidas: 370 X 90mm.
- IP 65.

Código	W	Lumens		Precio
Campana led C.O.B. en Aluminio				
HL515L	50W	2990	1	236,00

- 220-240V - 50-60Hz.
- Cuerpo aluminio inyectado
- LED C.O.B. 50W
- Lúmenes: 2990
- Medidas: 440 X 900mm.
- Color 6400K - IP 20





Código	W	Color		Precio
--------	---	-------	---	--------

Farola calle LED C.O.B. IP65

49862	1X30	Plata	1	166,60
-------	------	-------	---	---------------

- 110-240V - 50-60Hz.
- Cuerpo aluminio inyectado
- Lámpara LED C.O.B. 4200K
- Lúmenes: 3150
- Medidas: 500X222X82mm.
- Medidas tubo 53mm.

49863	1X50	Plata	1	218,00
-------	------	-------	---	---------------

- 110-240V - 50-60Hz.
- Cuerpo aluminio inyectado
- Lámpara LED C.O.B. 4200K
- Lúmenes: 5250
- Medidas: 580X226X92mm.
- Medidas tubo 50mm.

49864	2X50	Plata	1	360,00
-------	------	-------	---	---------------

- 110-240V - 50-60Hz.
- Cuerpo aluminio inyectado
- Lámpara LED C.O.B. 4200K
- Lúmenes: 10500
- Medidas: 680X238X92mm.
- Medidas tubo 63mm.

49865	3X50	Plata	1	460,00
-------	------	-------	---	---------------

- 110-240V - 50-60Hz.
- Cuerpo aluminio inyectado
- Lámpara LED C.O.B. 4200K
- Lúmenes: 15750
- Medidas: 811X267X92mm.
- Medidas tubo 63mm.

Conforme a las normas CE.
Utilización: patios, escaparates, monumentos, instalaciones deportivas, fachadas, etc.





Código	W	Lumens	Medidas		Precio
Campana en policarbonato inastillable					
HL501	300W		Transp.	5	34,80

- Lámpara máx. Bajo consumo 75W (no incluida).
- Portalámparas E27.
- Medidas: boca Ø 180mm.
- Largo total 90 cm.
- IP 20



Campana en policarbonato inastillable					
HL510	300W		Transp.	5	55,60

- Lámpara máx. Bajo consumo 65W (no incluida).
- Portalámparas E27.
- Medidas: boca Ø 335mm.
- Cadena hasta 1 metro.
- IP 20



Campana en policarbonato inastillable					
HL513	300W		Transp.	5	79,20

- Lámpara máx. Bajo consumo 80W (no incluida).
- Portalámparas E27.
- Medidas: boca Ø 413mm.
- Cadena hasta 1 metro.
- IP 20



Conforme a las normas CE.
 Utilización: patios, escaparates, monumentos,
 instalaciones deportivas, fachadas, etc.

SERIE BEGONYA

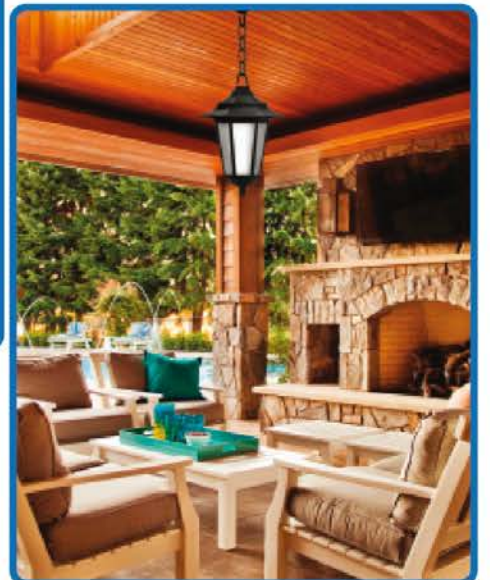
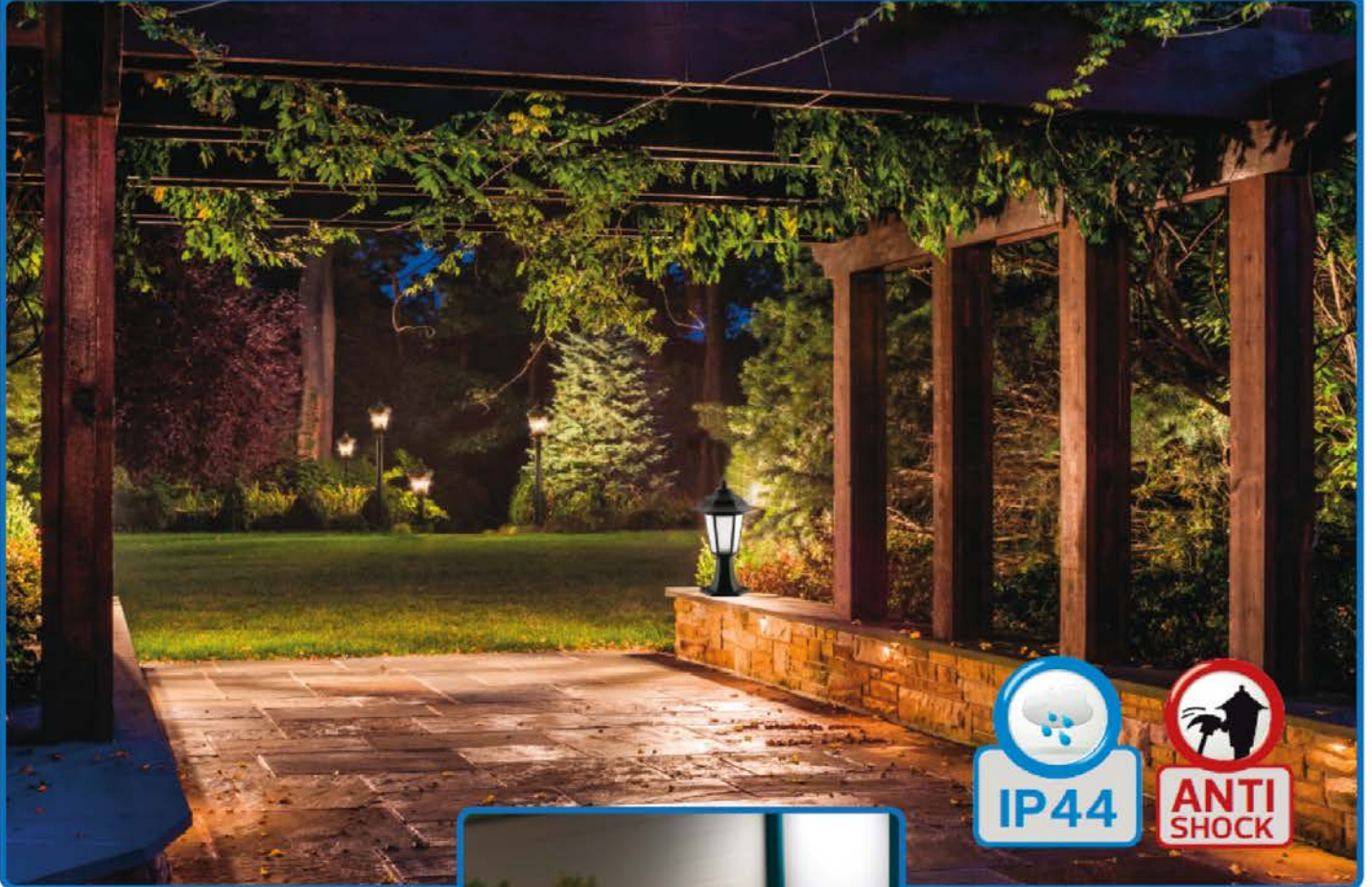

Serie Begonya

NO SE OXIDA

Polipropileno



Código	Color		Precio €
Farol colgar E27			
49351	Blanco	12	15,60
49352	Negro	12	15,60

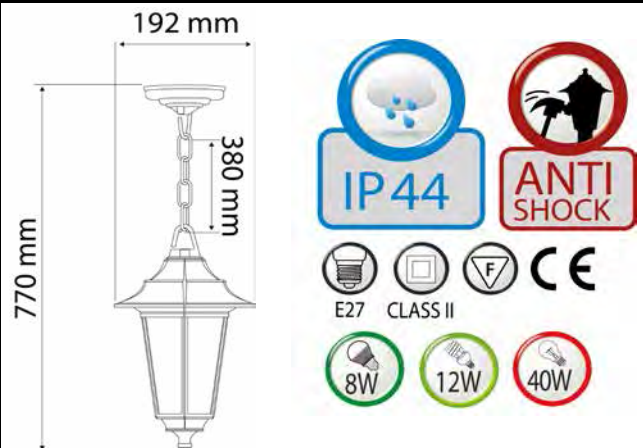

Farol pared E27			
49353	Blanco	12	15,60
49354	Negro	12	15,60

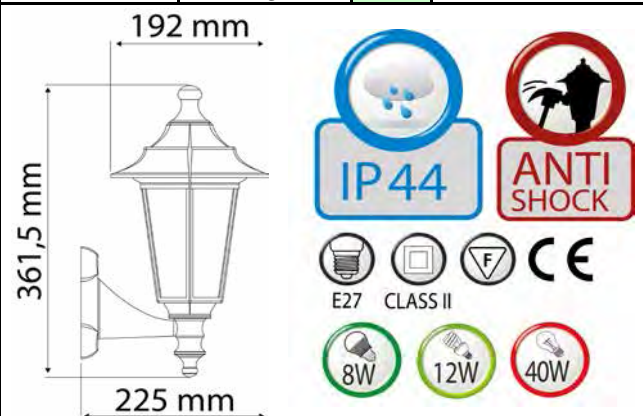

Farol sobremuro E27			
49355	Blanco	12	15,60
49356	Negro	12	15,60



Todos presentados en caja color.



Código	Color		Medida	Precio €
Farola aluminio 3 cabezas				
49489	Negro	6	2100X500	188,40

- Portalámparas 3xE27.
- Máx. 3x60W.
- IP44.

Farola aluminio 1 cabeza

49490	Negro	6	2100X500	143,60
-------	-------	---	----------	--------

- Portalámparas 3xE27.
- Máx. 60W.
- IP44.



Código	Color		Medida	Precio €
Farol aluminio colgar				
49470	Blanco	6	250X165	24,20
49471	Negro	6	250X165	24,20
49472	Rojo Ox.	6	250X165	24,20
49415	Verde Ox.	6	310X200	24,20



Farol aluminio pared

49460	Blanco	6	300X165	25,80
49461	Negro	6	300X165	25,80
49462	Rojo Ox.	6	300X165	25,80

Farol aluminio sobremuro

49465	Blanco	4	400X200	25,90
49466	Negro	4	370X165	25,90
49467	Rojo Ox.	4	370X165	25,90
49416	Verde Ox.	4	400X200	25,90

Todos presentados en caja color.





Código	Color		Medida	Precio €
Farol aluminio pared MD-TEXAS				
49475	Blanco	6	380x145	28,20
49476	Negro	6	380x145	28,20
49477	Rojo Ox.	6	380x145	28,20
49322	Verde Ox.	6	430x170	28,20



Farol aluminio colgar MD-TEXAS.				
49485	Blanco	12	320x145	26,60
49486	Negro	12	320x145	26,60
49487	Rojo Ox.	12	320x145	26,60

Farol aluminio sobremuro MD-TEXAS				
49480	Blanco	6	430x145	27,90
49481	Negro	6	430x145	27,90





Código	Color		Medida	Precio €
--------	-------	---	--------	----------

Farol inoxidable pared

49450	Inox.	6	330X215	53,10
-------	-------	---	---------	--------------

- Portalámparas E27.
- Máx. 60W.

Farol inoxidable colgar

49451	Inox.	6	850X198	50,60
-------	-------	---	---------	--------------

- Portalámparas E27.
- Máx. 60W.

Farol inoxidable sobremuro

49452	Inox.	6	300X198	52,10
-------	-------	---	---------	--------------

- Portalámparas E27.
- Máx. 60W.

Farol inoxidable pared

HL217	Inox.	6	310x280	56,20
-------	-------	---	---------	--------------

- Portalámparas E27.
- Máx. 60W.
- IP44.

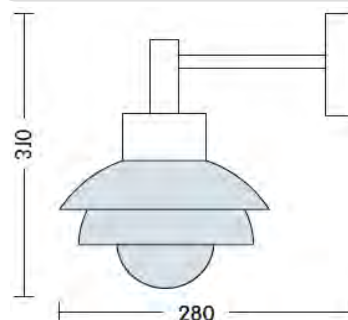

Homologadas:





Código	Color		Medida	Precio €
--------	-------	---	--------	----------

Farol inoxidable pared

49440	Inox.	6	405X76	18,75
-------	-------	---	--------	-------

Portalámparas E27.
Máx. 60W.

Farol inoxidable pared

49441	Inox.	6	344X142	28,50
-------	-------	---	---------	-------

Portalámparas E27.
Máx. 60W.

Farol inoxidable pie

49442	Inox.	6	325X110	22,45
-------	-------	---	---------	-------

Portalámparas E27.
Máx. 60W.

Farol inoxidable pie

49443	Inox.	6	500X110	27,45
-------	-------	---	---------	-------

Portalámparas E27.
Máx. 60W.



Farol inoxidable pie

49444	Inox.	6	800X110	40,60
-------	-------	---	---------	--------------

Portalámparas E27.
 Máx. 60W.
 IP44.

Homologadas:



1900mm.

Farol inoxidable 3 brazos

HL258P	Inox.	6	500X1900	246,60
--------	-------	---	----------	---------------

- Portalámparas E27.
 - Máx. 60W.
 - IP44.



Código	Color		Medida	Precio €
--------	-------	---	--------	----------

Aplique pared inoxidable

49497	Inox.	6	100X315	26,20
-------	-------	---	---------	-------

- Portalámparas E27.
- Máx. 75W.
- IP44.

Aplique pared inoxidable

49498	Inox.	6	100X315	26,20
-------	-------	---	---------	-------

- Portalámparas E27.
- Máx. 75W.
- IP44.

Aplique pared led 1,8W 6000K

46071		18		42,45
-------	--	----	--	-------

- Medida exterior: Alto:138 Ancho: 140mm
- Medida interior: Alto: 128mm Profundo: 87mm
- Lumenes: 105
- IP54

Aplique pared 18 led 1,8W 6000K

46072		18		56,90
-------	--	----	--	-------

- Medida exterior: Alto:234 Ancho: 140mm
- Medida interior: Alto: 224mm Profundo: 87mm
- Lumenes: 105
- IP54

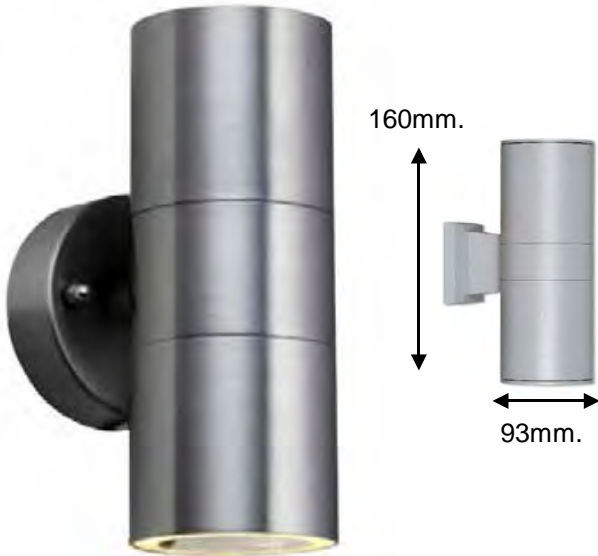
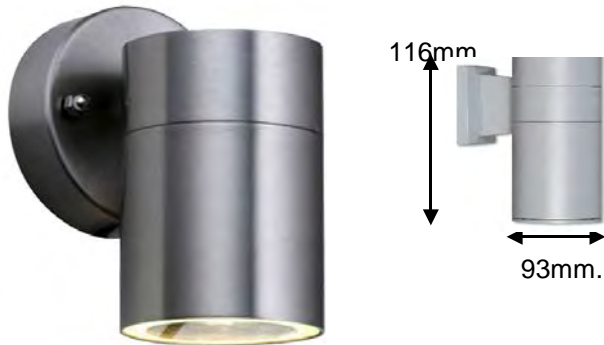

Código	Color		Precio €
--------	-------	---	----------

Aplique pared 1 luz

49437	Acero	10	24,90
-------	-------	----	-------

- Portalámparas GU10.
- Lámpara GU10 máx. 35W.
- Halógena.
- Cuerpo en acero inox.
- Lámparas no incluidas.

Aplique pared 2 luces

49438	Acero	10	36,80
-------	-------	----	-------

- Portalámparas 2 x GU10.
- Lámpara GU10 máx. 35W.
- Halógena.
- Cuerpo en acero inox.
- Lámparas no incluidas.

Aplique 7W SMD LED IP20

77819	Blanco	10	4200K	17,90
77684	Blanco	10	6000K	17,90

- Cuerpo ABS.
- Medidas: Ø 85mm, fondo: 77mm.
- Medida corte: 60mm.
- IP20.
- Lumen: 580 lm.
- Oscilable.

Aplique 6W COB LED 4200K IP65

46025	Blanco	10	4200K	22,90
-------	--------	----	-------	-------

- Medidas: Ø 90mm, fondo: 61mm.
- Medida corte: 80mm.
- IP65.
- Lumen: 410 lm.

APLIQUES EN ALUMINIO PARA USO EXTERIOR



DOBLE LUZ



Código	Modelo		Precio €
Aplique pared led 5,5W 220-240V / 50-60Hz.			
42801	245mm.	8	52,80

- IP44 Color Negro
- Luz: 4100K - 385 lúmenes.
- Medida: 245X125X65mm.

LED
5,5W

Aplique pared led 5,5W 220-240V / 50-60Hz.

42802	300mm.	12	52,80
-------	--------	----	-------

- IP44 Color Negro
- Luz: 4100K - 420 lúmenes.
- Medida: 300X90X65mm.

LED
3,5W

Aplique pared led 3W 220-240V / 50-60Hz.

42804	300mm.	12	47,80
-------	--------	----	-------

- IP44 Color Negro
- Luz: 4100K - 230 lúmenes.
- Medida: 300X80X70mm.

LED
3,5W

APLIQUES EN ALUMINIO PARA USO EXTERIOR

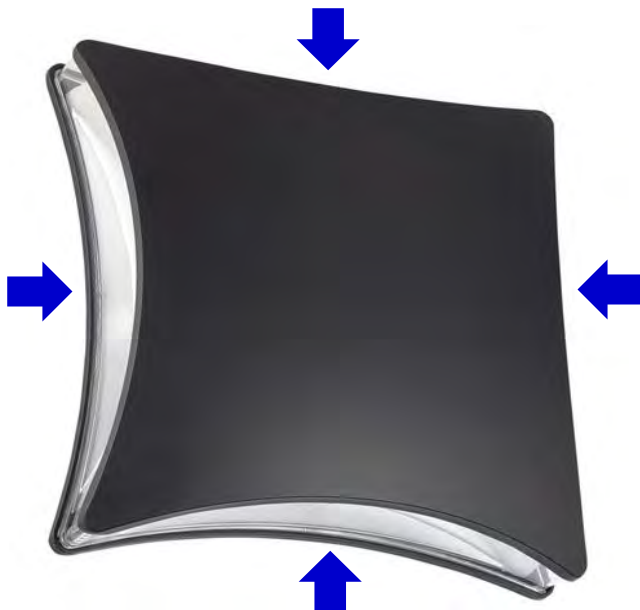

Código	Modelo		Precio €
Aplicque pared led 5,5W 220-240V / 50-60Hz.			
42805	205mm.	12	69,80

- IP44 Color Negro
- Luz: 4100K - 200 lúmenes.
- Medida: 205X73mm.

LED
5,5W

4 LUCES



Aplicque pared led 3,5W 220-240V / 50-60Hz.			
42807	84mm.	24	42,40

- IP44 Color Negro
- Luz: 4100K - 35 lúmenes.
- Medida: 300X90X65mm.

LED
3,5W

DOBLE LUZ



Aplicque pared led 3W 220-240V / 50-60Hz.			
42808	84mm.	16	42,40

- IP44 Color Negro
- Luz: 4100K - 65 lúmenes.
- Medida: 84X170X130mm.

LED
3,5W

DOBLE LUZ



Código	Color		Precio €
--------	-------	---	----------

Pica solar LED

49424		24	5,90
-------	--	----	------

- Carcasa ABS
- Medidas altura: 405x116 mm.
- IP clase III 45.
- 1 Batería recargable.
- Interruptor crepuscular (se enciende solo por la noche).
- Autonomía con sol de 6 a 8 horas.

Pica solar LED

49425		12	12,90
-------	--	----	-------

- Estructura inox y campana de cristal
- Medidas altura: 390x135 mm.
- IP clase III 45.
- 1 Batería recargable.
- Interruptor crepuscular (se enciende solo por la noche).
- Autonomía con sol de 6 a 8 horas.

Pica solar LED

49423		12	12,90
-------	--	----	-------

- Estructura inox y campana de cristal
- Medidas altura: 4720x140 mm.
- IP clase III 45.
- 1 Batería recargable.
- Interruptor crepuscular (se enciende solo por la noche).
- Autonomía con sol de 6 a 8 horas.

Pica solar LED

49428		12	8,60
-------	--	----	------

- Estructura inox y campana de cristal
- Medidas altura: 383x115 mm.
- IP clase III 45.
- 1 Batería recargable.
- Interruptor crepuscular (se enciende solo por la noche).
- Autonomía con sol de 6 a 8 horas.





Código	Color		Precio €
Set 5 Picas solares LED			
49426		6	15,60

- Carcasa ABS
- Medidas altura: 365x47 mm.
- IP clase III 45.
- 1 Batería recargable.
- Interruptor crepuscular (se enciende solo por la noche).
- Autonomía con sol de 6 a 8 horas.

SET DE 5 PZAS.

Código	Color		Precio €
Set 5 Picas solares LED			
49427		6	22,10

- Estructura inox y campana de cristal
- Medidas altura: 369x76 mm.
- IP clase III 45.
- 1 Batería recargable.
- Interruptor crepuscular (se enciende solo por la noche).
- Autonomía con sol de 6 a 8 horas.

SET DE 5 PZAS.

Código	Color		Precio €
Farol de aceite			
20551	Rojo	12	10,60
20553	Azul	12	10,60

- Regulable.



**LED
3,5W**



**LED
5W**



**LED
16W**

Código	Modelo		Precio €
--------	--------	---	----------

Pica de Led **3,5W** 220-240V / 50-60Hz.

HL283L	270mm.	6	26,90
--------	--------	---	--------------

- IP65 con cable 2X1.
- Luz: 6400K.
- 240 lúmenes.
- Medida: diámetro del foco 75mm.



Pica de Led **5W** 220-240V / 50-60Hz.

49421	272mm	6	29,90
-------	-------	---	--------------

- IP65 con cable 2X1.
- Luz: 6400K.
- 340 lúmenes.
- Medida: diámetro del foco 80mm.



Pica de Led **16W** 220-240V / 50-60Hz.

49422	310mm	6	39,90
-------	-------	---	--------------

- IP65 con cable 2X1.
- Luz: 6400K.
- 1097 lúmenes.
- Medida: diámetro del foco 110mm.





Código		tarifa
Aplicador solar 10LED 2W LED para pared		
49430	12	27,90

- Carcasa ABS.
- Medidas aplicador 155x65 mm.
- Medidas placa solar 110X80mm.
- IP clase III 45.
- 3 Baterías recargables.
- Interruptor crepuscular (se enciende solo por la noche).



Aplicador solar 15LED para pared CON SENSOR		
4991729	24	34,95

- Carcasa ABS.
- Medidas aplicador 130x80 mm.
- Medidas placa solar 175X100mm.
- IP clase III 45.
- 3 Baterías recargables.
- Autonomía con sol de 6 a 8 horas.



Set 3 Picas solares LED 9x0,06W		
49429	6	29,60

- Estructura inox y campana de cristal
- Medidas altura: 320x100 mm.
- IP clase III 45.
- 1 Batería recargable.
- Interruptor crepuscular (se enciende solo por la noche).
- Autonomía con sol de 6 a 8 horas.



Set 3 Picas solares LED		
4922858	12	17,20

- Estructura inox
- Medidas altura: 800mm.
- IP clase III 45.
- 1 Batería recargable.
- Interruptor crepuscular (se enciende solo por la noche).
- Autonomía con sol de 6 a 8 horas.